



# TAOGLAS®



# Datasheet

## 5G/4G Terminal Mount Monopole Antenna

**Part No:**  
TG.55.8723

**Description:**

5G/4G Terminal Mount Monopole Antenna 90° Hinged FAKRA Code D

**Features:**

- Covering Sub 6GHz 5G NR Bands
- Covering Worldwide 4G Bands
- 600MHz-6GHz Bandwidth
- High Efficiency up to 80%
- 3G/2G Fallback with NB-IoT and CAT-M capabilities
- 90° Hinged Right Angle FAKRA Code D connector
- Straight Dimensions: 172 x 23.9 x 13 mm
- Right Angle Dimensions: 148 x 42.4 x 13 mm
- RoHS & REACH Compliant

1. Introduction	3
2. Specifications	4
3. Antenna Characteristics	7
4. Radiation Patterns	9
5. Mechanical Drawing	75
6. Packaging	76
7. Application Note	77
<hr/>	
Changelog	79

Taoglas makes no warranties based on the accuracy or completeness of the contents of this document and reserves the right to make changes to specifications and product descriptions at any time without notice. Taoglas reserves all rights to this document and the information contained herein. Reproduction, use or disclosure to third parties without express permission is strictly prohibited.



# 1. Introduction



The Taoglas TG.55.8113 is a 5G/4G monopole antenna, designed primarily for use with modules and devices that require high efficiency and peak gain. It delivers best in class throughput on all major cellular bands worldwide, perfect for access points, terminals, and routers. The TG.55 covers many 5G NR Sub 6GHz bands including the new Extended LTE Band 71. It has an SMA (M) connector as standard and is an ideal solution for any device requiring reliable performance in a slim form factor.

Typical Applications include:

- Gateways & Routers
- Smart Metering
- Vending Machines
- Industrial IoT
- Smart Home
- Connected Enterprise

The TG.55 exhibits an efficiency of up to 80% across wideband 5G/4G bands and is backward compatible with 3G/2G cellular applications. The TG.55 is a fully omnidirectional antenna as seen in the radiation patterns and is stable across all bands. The SMA (M) connector hinge mechanism allows the antenna to be rotated into the preferred orientation which helps to avoid other antennas or objects. This also helps with isolation by pointing the antennas in different directions when used in MIMO systems or when other antennas are present on the same device. The antenna blade can swivel 90 degrees from the connector accommodating different installation configurations.

The TG.55.8113 is also available with a white enclosure – TG.55.8113W. The connector can also be customized based on an MOQ.

Contact your regional Taoglas customer support team to request these services or additional support to integrate and test this antenna’s performance in your device.

## 2. Specifications

Electrical										
Frequency (MHz)	5G NR Band 71	LTE 700	GSM 850/900	5G NR B 74, 75, 76	GPS L1	DCS	UMTS1	LTE 2600	5G NR B 77, 78, 79	LTE 5200
	617 ~698	698 ~824	824 ~960	1427 ~1518	1563 ~1587	1710 ~1880	1920 ~2170	2300 ~2690	3300 ~5000	5150 ~5925
Efficiency (%)										
Free space straight	35.93	25.92	38.33	38.08	46.37	69.80	59.03	44.92	50.45	45.96
Free space bent	43.77	30.56	51.77	44.23	53.07	78.02	65.02	51.53	48.91	34.98
On 30x30 cm GND edge straight	44.39	39.43	59.39	49.21	57.94	66.24	52.47	42.63	24.71	21.90
On 30x30 cm GND edge bent	42.05	30.02	52.28	46.78	48.79	68.89	54.17	39.78	21.31	22.53
On 30x30 cm GND centre straight	9.12	7.30	21.46	38.09	51.59	65.46	48.14	42.25	36.68	24.48
On 30x30 cm GND centre bent	4.88	10.77	34.32	36.52	46.16	60.36	47.55	42.15	36.82	21.93
Average Gain (dB)										
Free space straight	-4.45	-5.86	-4.16	-4.19	-3.34	-1.56	-2.29	-3.48	-2.97	-3.38
Free space bent	-3.59	-5.15	-2.86	-3.54	-2.75	-1.08	-1.87	-2.88	-3.11	-4.56
On 30x30 cm GND edge straight	-3.53	-4.04	-2.26	-3.08	-2.37	-1.79	-2.80	-3.70	-6.07	-6.60
On 30x30 cm GND edge bent	-3.76	-5.23	-2.82	-3.30	-3.12	-1.62	-2.66	-4.00	-6.71	-6.47
On 30x30 cm GND centre straight	-10.40	11.37	-6.68	-4.19	-2.87	-1.84	-3.17	-3.74	-4.36	-6.11
On 30x30 cm GND centre bent	-13.12	-9.68	-4.64	-4.37	-3.36	-2.19	-3.23	-3.75	-4.34	-6.59
Peak Gain (dBi)										
Free space straight	-0.68	-2.14	0.15	-0.74	-0.59	1.37	0.93	0.73	1.51	1.73
Free space bent	0.14	-1.88	0.58	0.87	1.98	3.09	2.45	1.69	1.50	0.70
On 30x30 cm GND edge straight	0.94	-0.32	2.56	1.00	1.26	1.93	1.42	1.24	-0.84	-1.48
On 30x30 cm GND edge bent	0.63	-1.99	-0.02	-0.59	0.37	1.66	0.49	0.13	0.53	-0.25
On 30x30 cm GND centre straight	-5.47	-5.46	0.02	0.75	2.30	3.44	2.48	2.36	4.66	2.40
On 30x30 cm GND centre bent	-9.07	-6.11	-1.12	3.76	4.99	6.10	4.84	3.46	3.92	1.80
<b>Impedance</b>	50Ω									
<b>Polarization</b>	Linear									
<b>Radiation Pattern</b>	Omni									
<b>Max. input power</b>	2W									



<b>Mechanical</b>	
<b>SMA Connector Diameter</b>	13mm
<b>Planner Dimension</b>	172mm * 23.88mm
<b>Casing</b>	ABS + PC
<b>Connector</b>	FAKRA Code D Bordeaux Violet
<b>Weight</b>	24.3g
<b>Environmental</b>	
<b>Temperature Range</b>	-40°C to 85°C
<b>Humidity</b>	Non-condensing 65°C 95% RH

5G/4G Bands								
Band Number	5GNR / FR1 / LTE / LTE-Advanced / WCDMA / HSPA / HSPA+ / TD-SCDMA							
	Uplink	Downlink	Free space Bent	Free space Straight	30x30cm GND edge bent	30x30cm GND edge straight	30x30cm GND centre bent	30x30cm GND centre straight
1	UL: 1920 to 1980	DL: 2110 to 2170	✓	✓	✓	✓	✓	✓
2	UL: 1850 to 1910	DL: 1930 to 1990	✓	✓	✓	✓	✓	✓
3	UL: 1710 to 1785	DL: 1805 to 1880	✓	✓	✓	✓	✓	✓
4	UL: 1710 to 1755	DL: 2110 to 2155	✓	✓	✓	✓	✓	✓
5	UL: 824 to 849	DL: 869 to 894	✓	✓	✓	✓	✓	✓
7	UL: 2500 to 2570	DL: 2620 to 2690	✓	✓	✓	✓	✓	✓
8	UL: 880 to 915	DL: 925 to 960	✓	✓	✓	✓	✓	✓
9	UL: 1749.9 to 1784.9	DL: 1844.9 to 1879.9	✓	✓	✓	✓	✓	✓
11	UL: 1427.9 to 1447.9	DL: 1475.9 to 1495.9	✓	✓	✓	✓	✓	✓
12	UL: 699 to 716	DL: 729 to 746	✓	✓	✓	✓	✓	✓
13	UL: 777 to 787	DL: 746 to 756	✓	✓	✓	✓	✓	✓
14	UL: 788 to 798	DL: 758 to 768	✓	✓	✓	✓	✓	✓
17	UL: 704 to 716	DL: 734 to 746	✓	✓	✓	✓	✓	✓
18	UL: 815 to 830	DL: 860 to 875	✓	✓	✓	✓	✓	✓
19	UL: 830 to 845	DL: 875 to 890	✓	✓	✓	✓	✓	✓
20	UL: 832 to 862	DL: 791 to 821	✓	✓	✓	✓	✓	✓
21	UL: 1447.9 to 1462.9	DL: 1495.9 to 1510.9	✓	✓	✓	✓	✓	✓
22	UL: 3410 to 3490	DL: 3510 to 3590	✓	✓	✓	✓	✓	✓
23	UL: 2000 to 2020	DL: 2180 to 2200	✓	✓	✓	✓	✓	✓
24	UL: 1625.5 to 1660.5	DL: 1525 to 1559	✓	✓	✓	✓	✓	✓
25	UL: 1850 to 1915	DL: 1930 to 1995	✓	✓	✓	✓	✓	✓
26	UL: 814 to 849	DL: 859 to 894	✓	✓	✓	✓	✓	✓
27	UL: 807 to 824	DL: 852 to 869	✓	✓	✓	✓	✓	✓
28	UL: 703 to 748	DL: 758 to 803	✓	✓	✓	✓	✓	✓
29	UL: -	DL: 717 to 728	✓	✓	✓	✓	✓	✓
30	UL: 2305 to 2315	DL: 2350 to 2360	✓	✓	✓	✓	✓	✓
31	UL: 452.5 to 457.5	DL: 462.5 to 467.5	✗	✗	✗	✗	✗	✗
32	UL: -	DL: 1452 – 1496	✓	✓	✓	✓	✓	✓
35		1850 to 1910	✓	✓	✓	✓	✓	✓
38		2570 to 2620	✓	✓	✓	✓	✓	✓
39		1880 to 1920	✓	✓	✓	✓	✓	✓
40		2300 to 2400	✓	✓	✓	✓	✓	✓
41		2496 to 2690	✓	✓	✓	✓	✓	✓
42		3400 to 3600	✓	✓	✓	✓	✓	✓
43		3600 to 3800	✓	✓	✓	✓	✓	✓
48		3550 to 3700	✓	✓	✓	✓	✓	✓
66	UL: 1710-1780	DL: 2110-2200	✓	✓	✓	✓	✓	✓
71		617 to 698	✓	✓	✓	✓	✗	✗
74/75/76		1427 to 1518	✓	✓	✓	✓	✓	✓
77		3300 to 4200	✓	✓	✓	✓	✓	✓
78		3300 to 3800	✓	✓	✓	✓	✓	✓
79		4400 to 5000	✓	✓	✓	✓	✓	✓

## 3. Antenna Characteristics

### 3.1 Return Loss

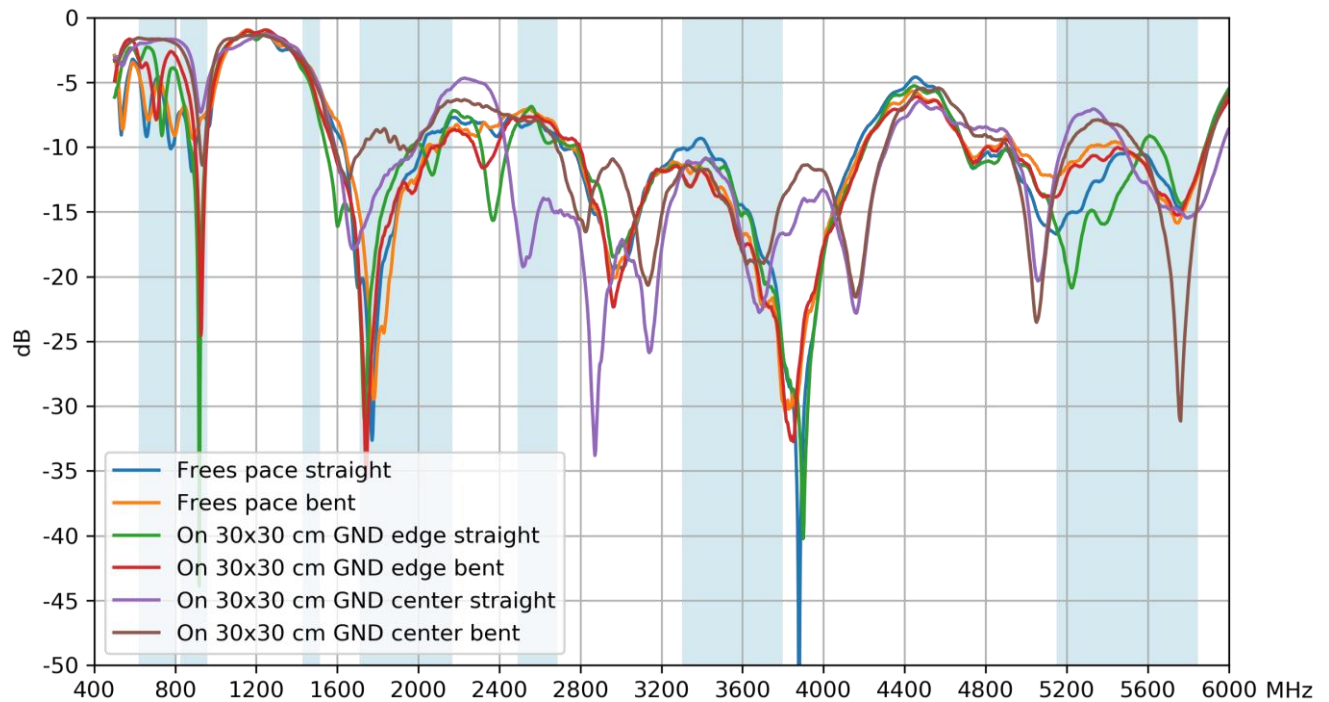

### 3.2 Efficiency

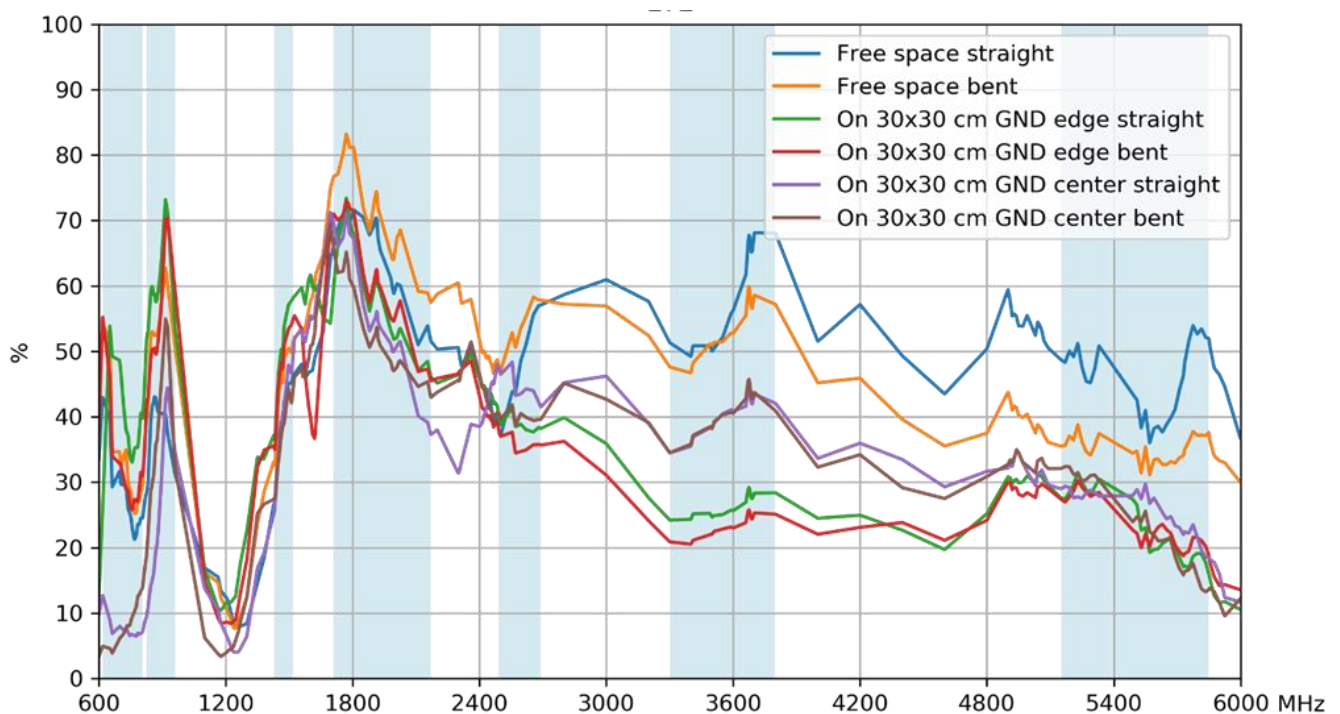

### 3.3 Average Gain

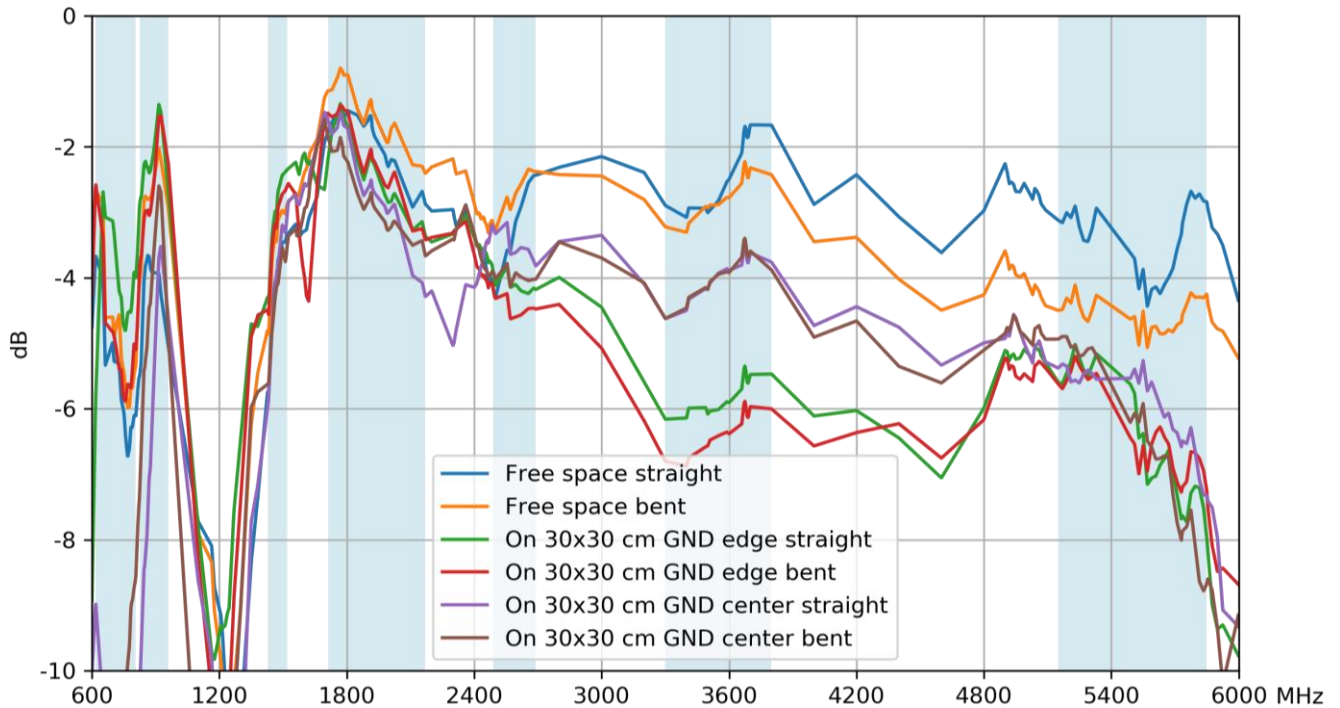

### 3.4 Peak Gain

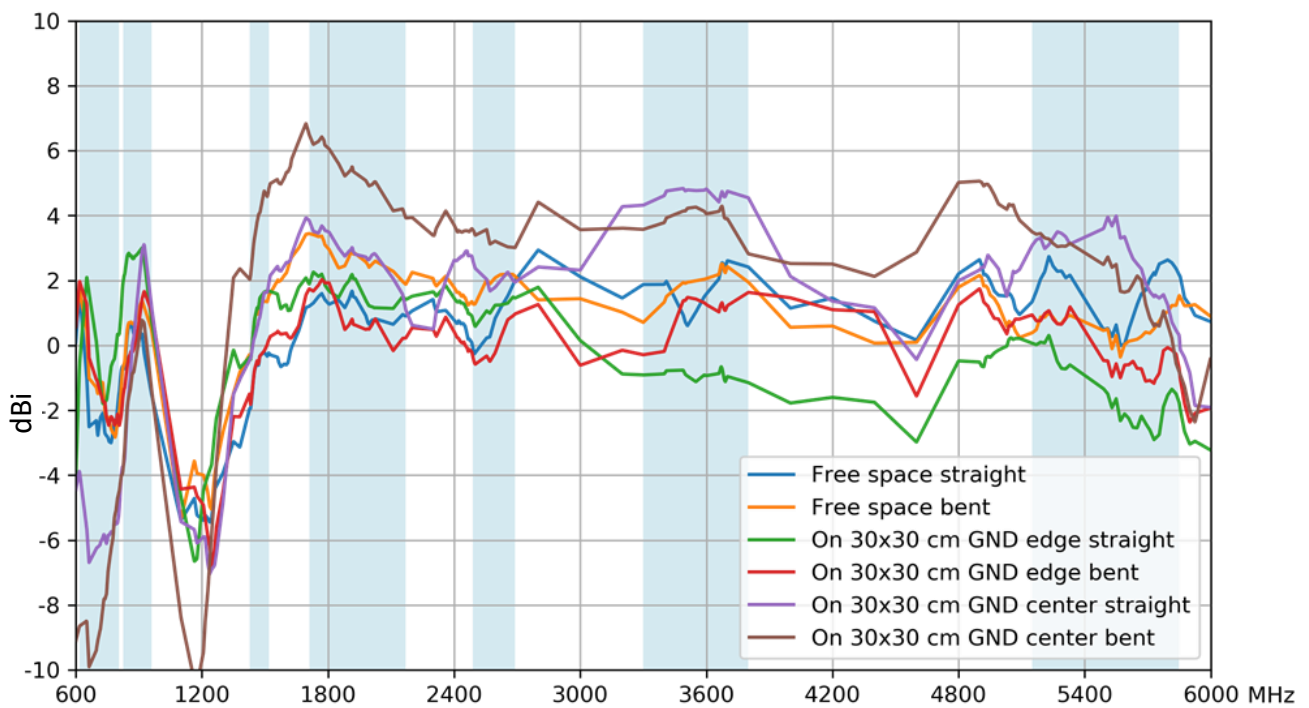

## 4. Radiation Patterns

### 4.1 Test Setup

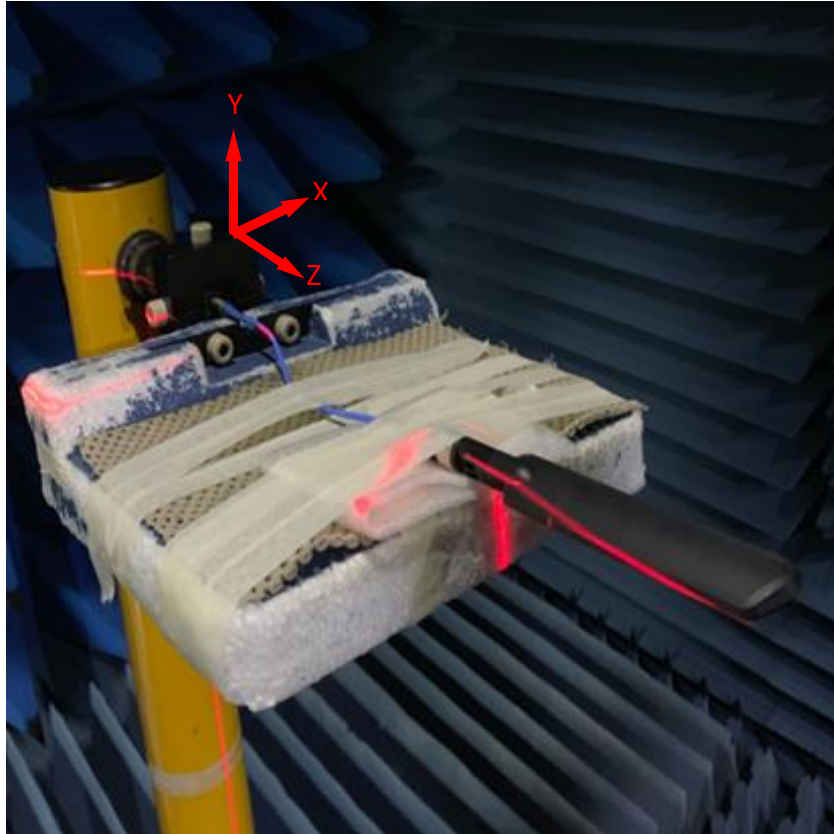

Straight Free Space

4.2 Straight 2D & 3D Radiation Patterns

652MHz

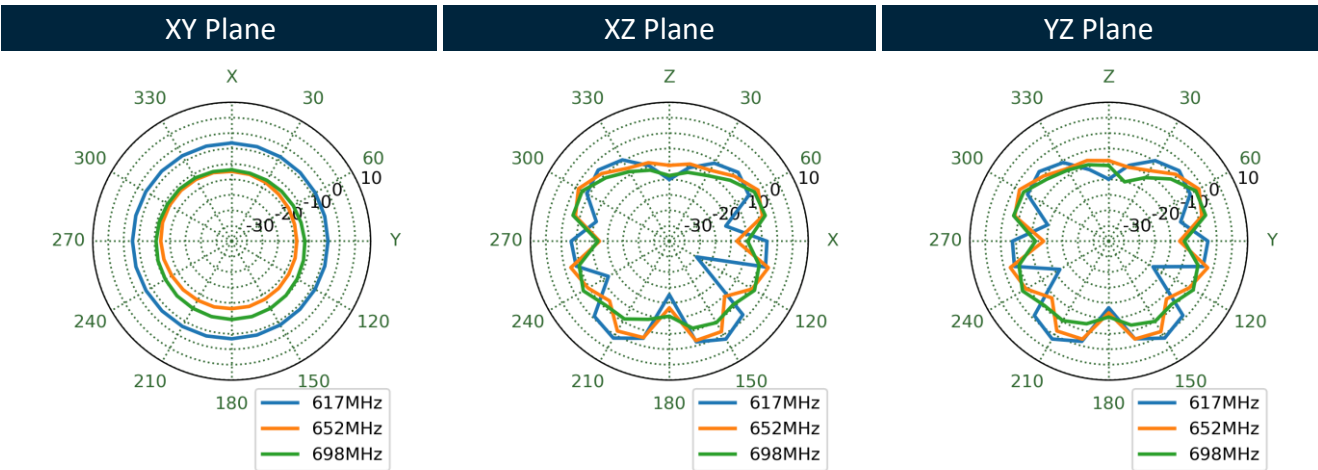
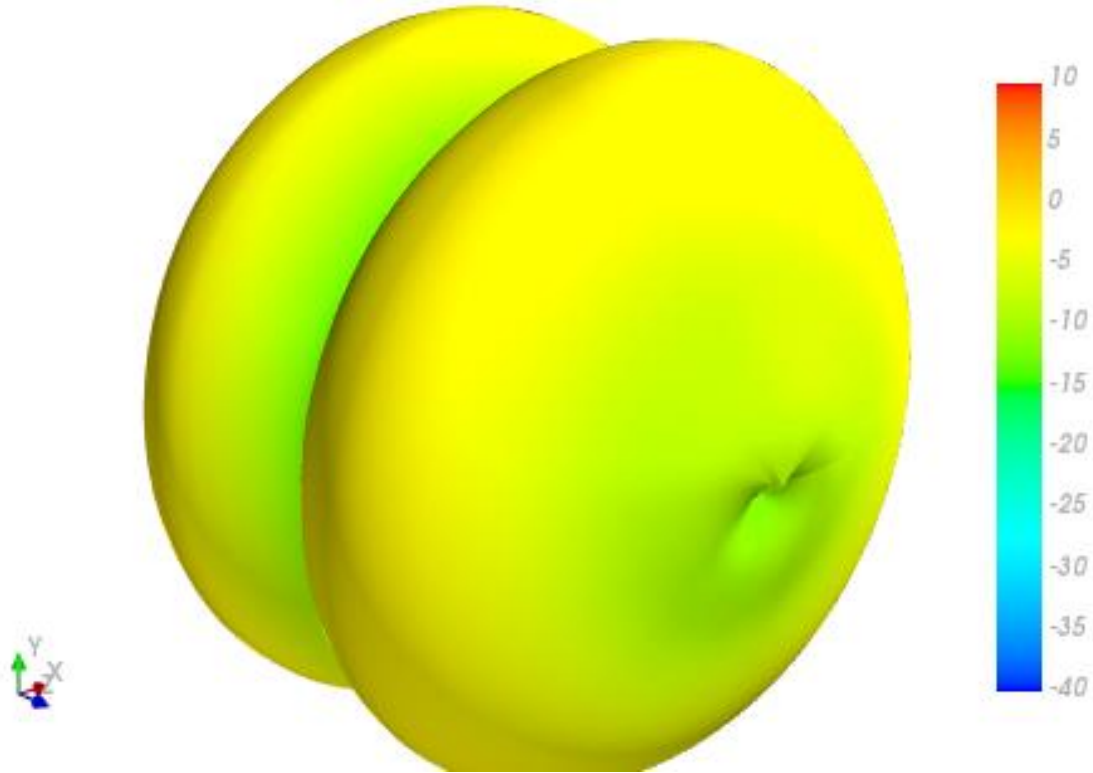



751MHz

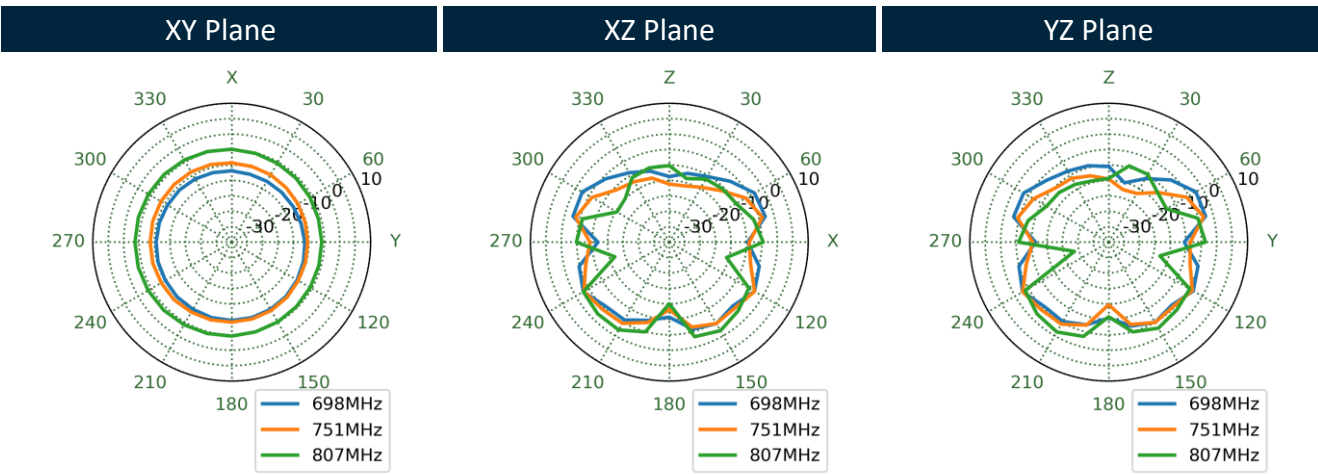
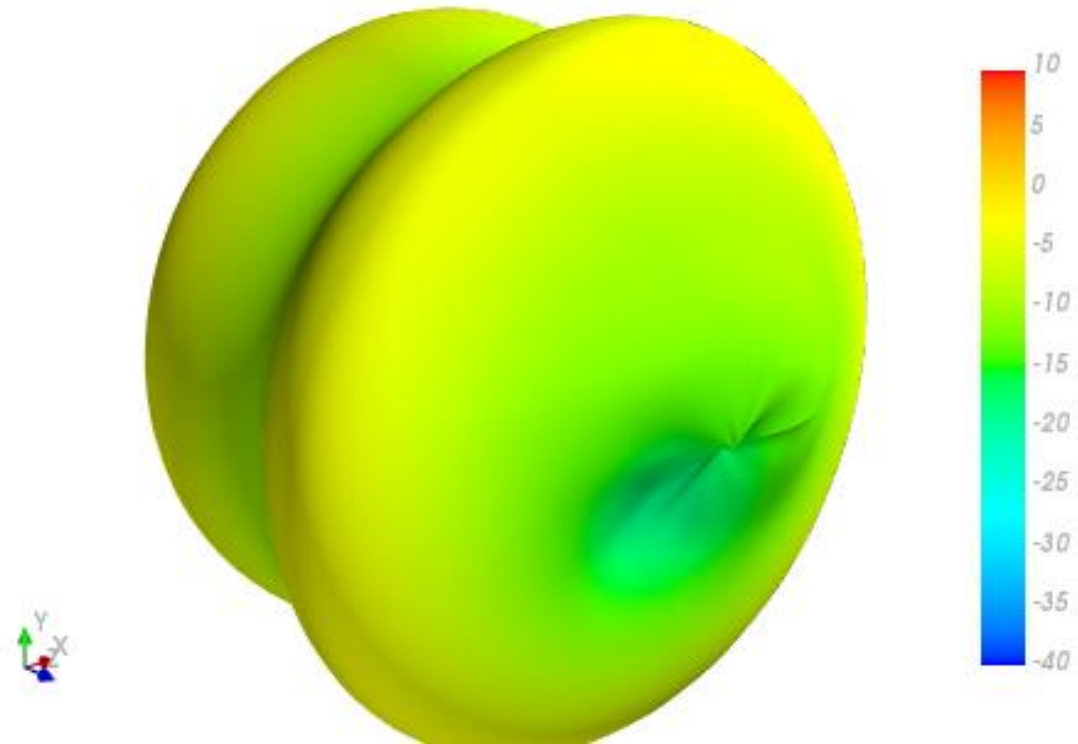



890MHz

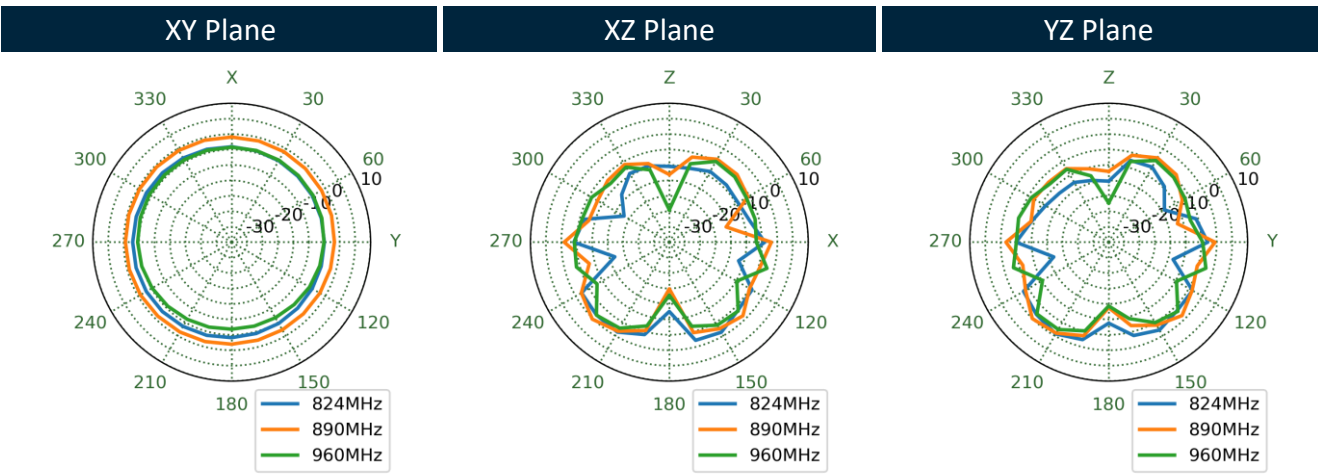
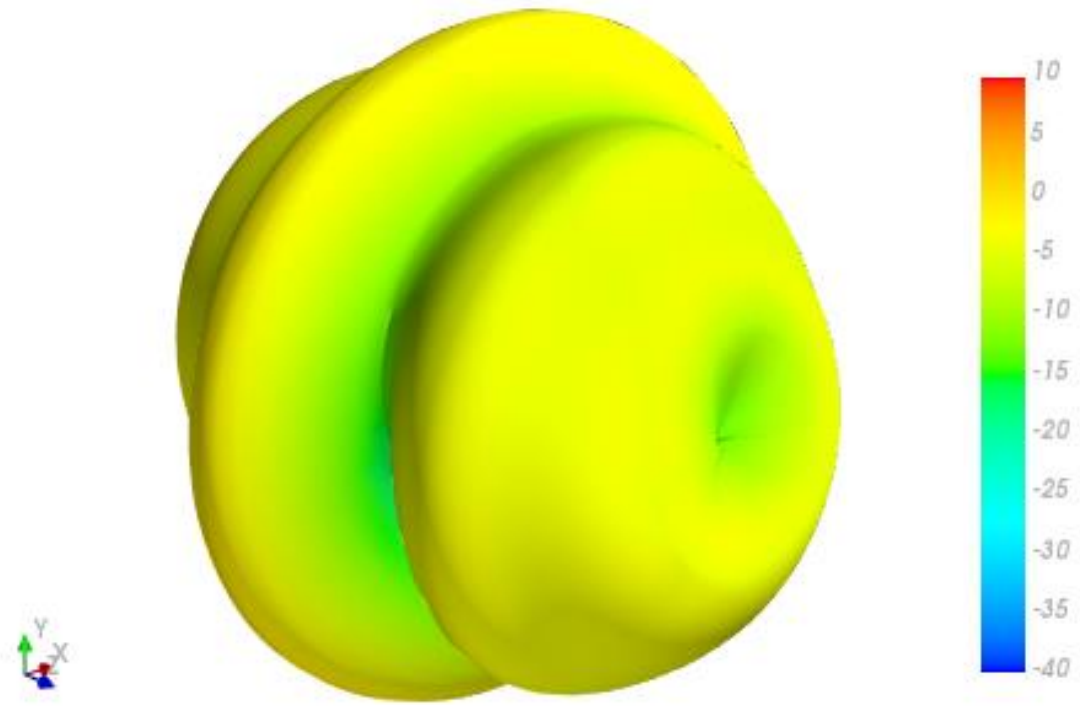

1470MHz

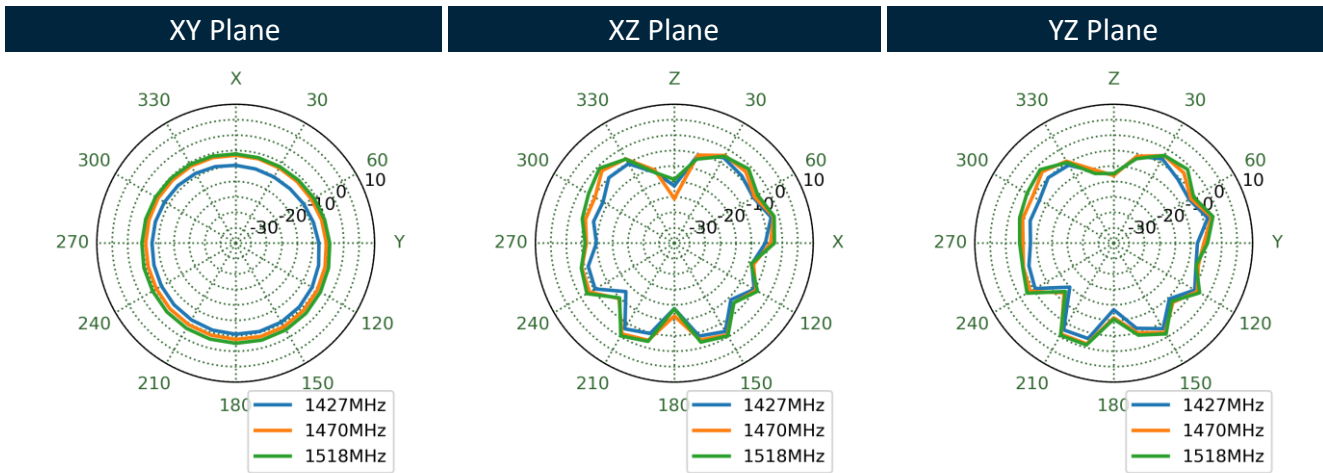
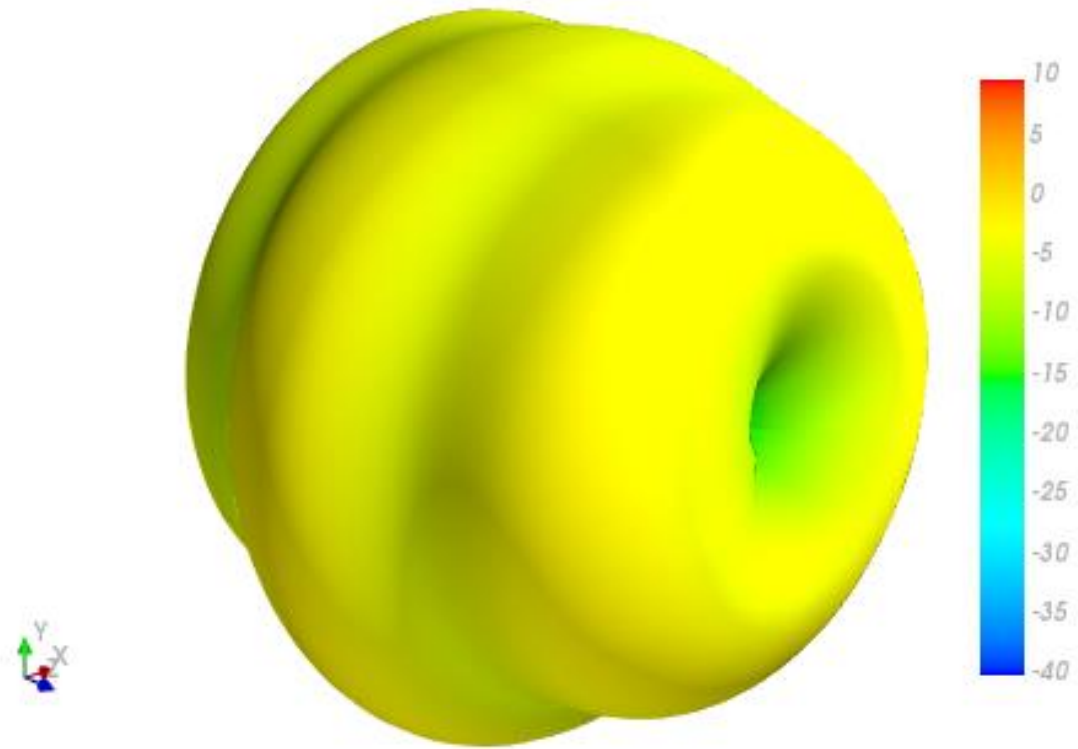

1805MHz

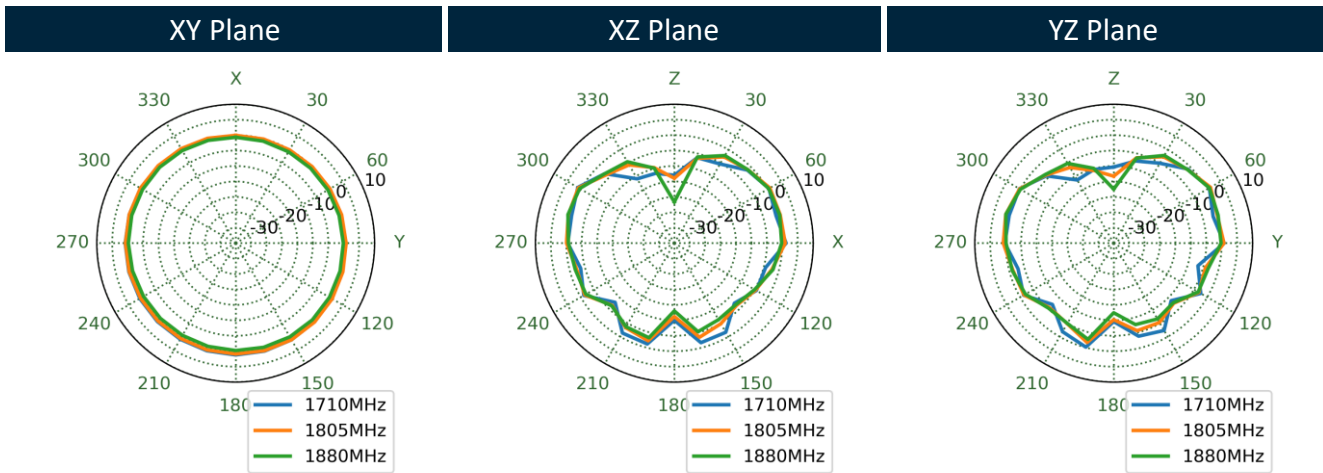
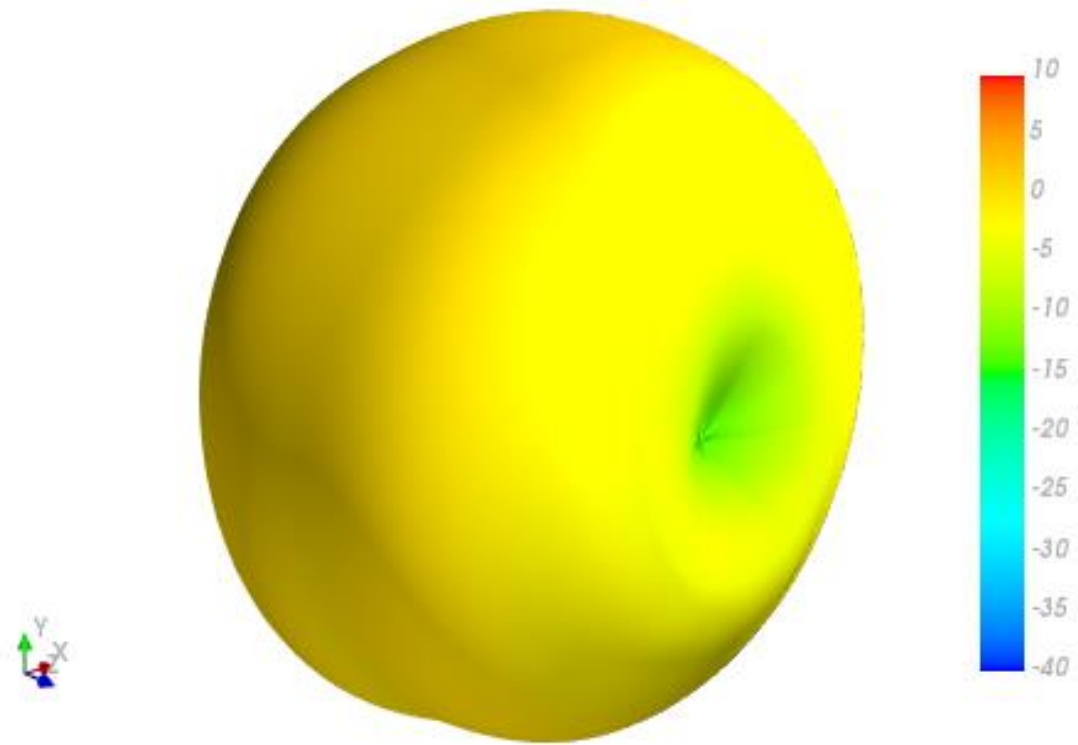

1920MHz

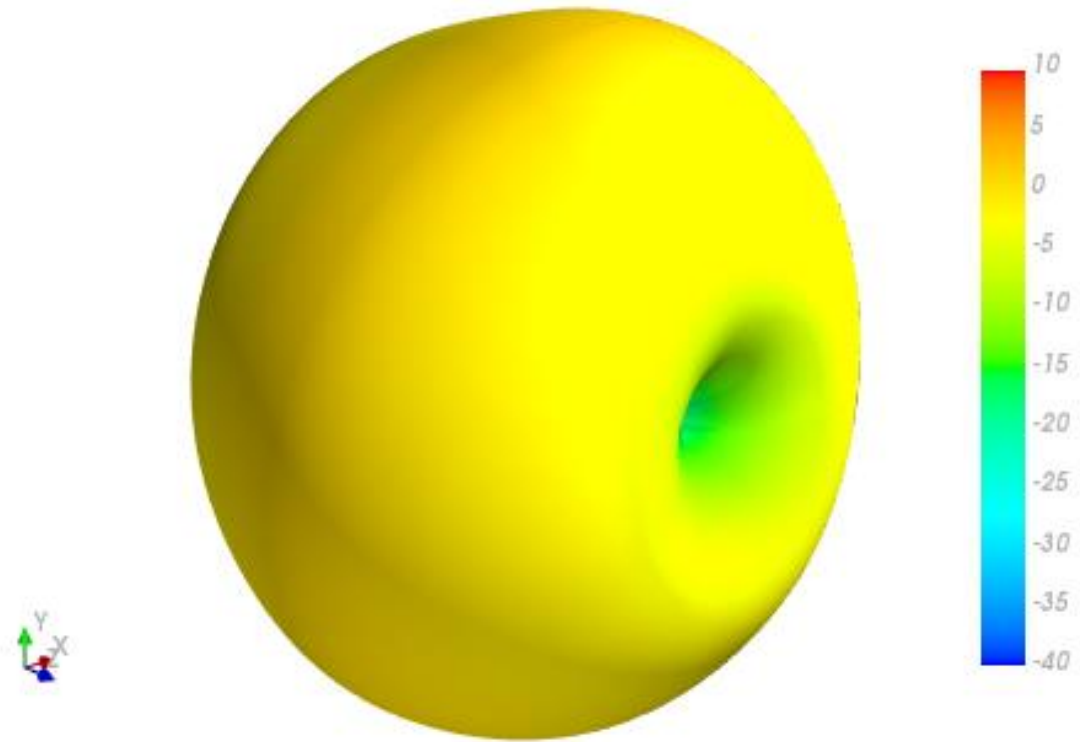

XY Plane      XZ Plane      YZ Plane

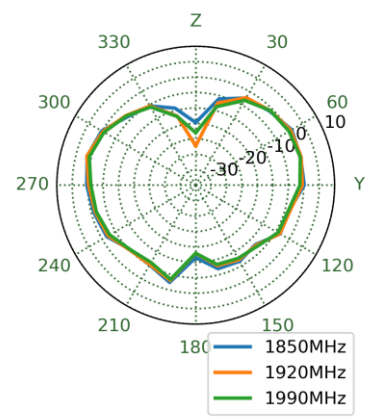
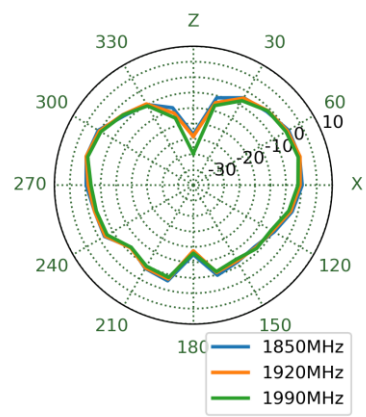
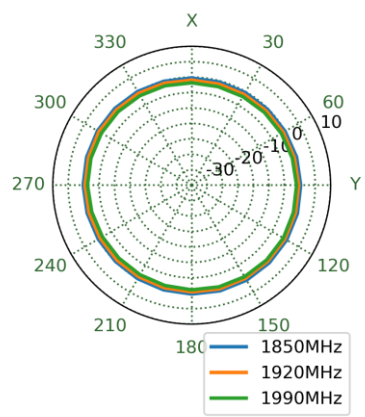

1990MHz

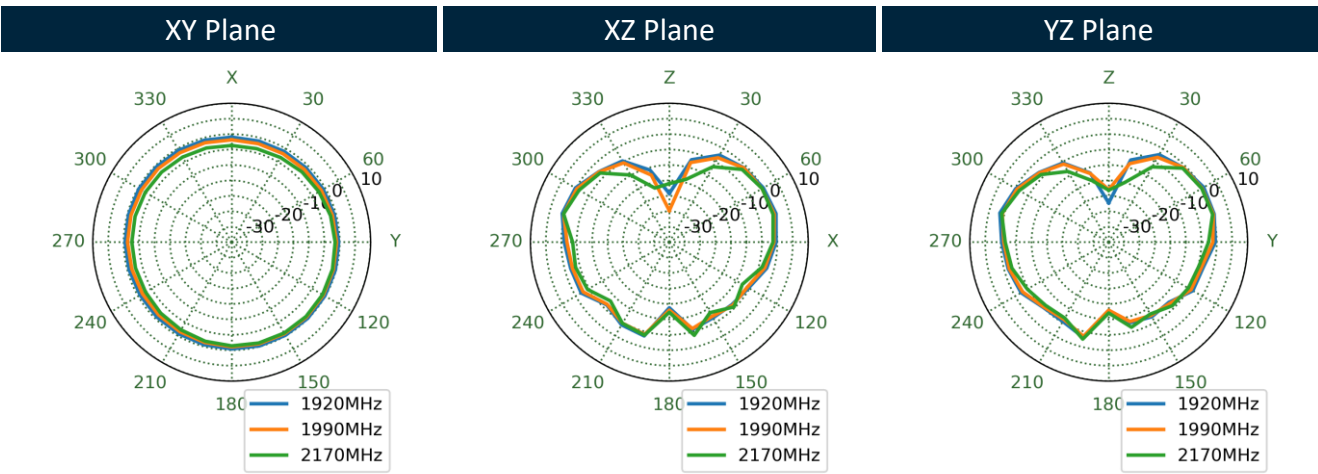
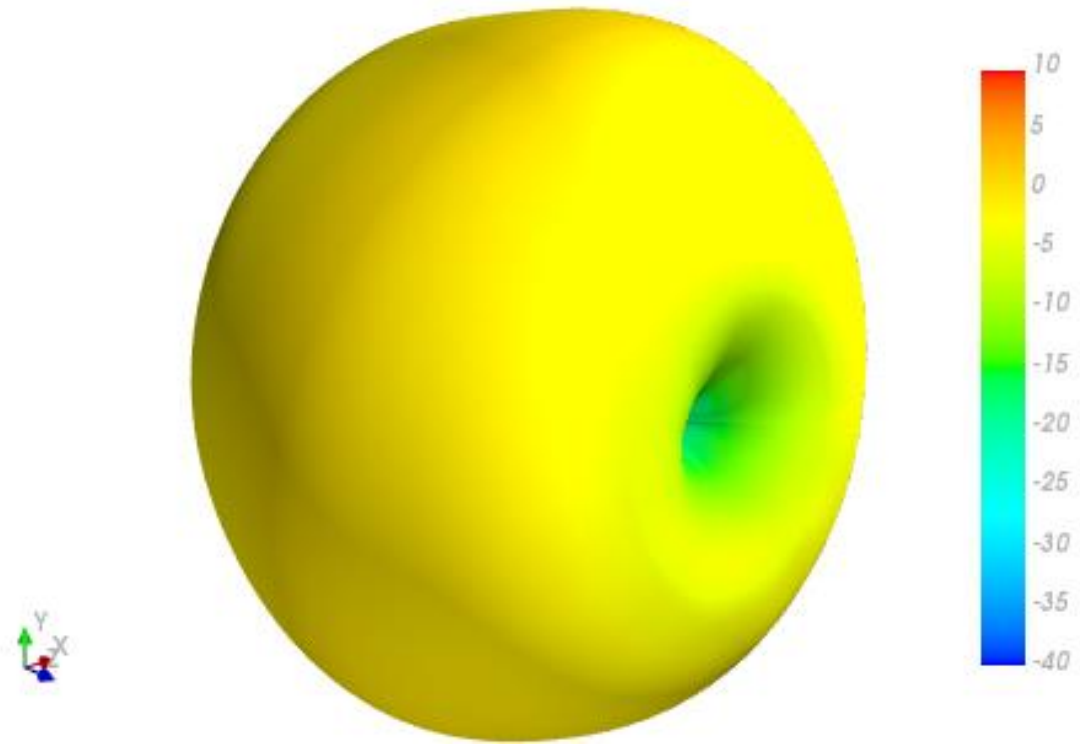

2595MHz

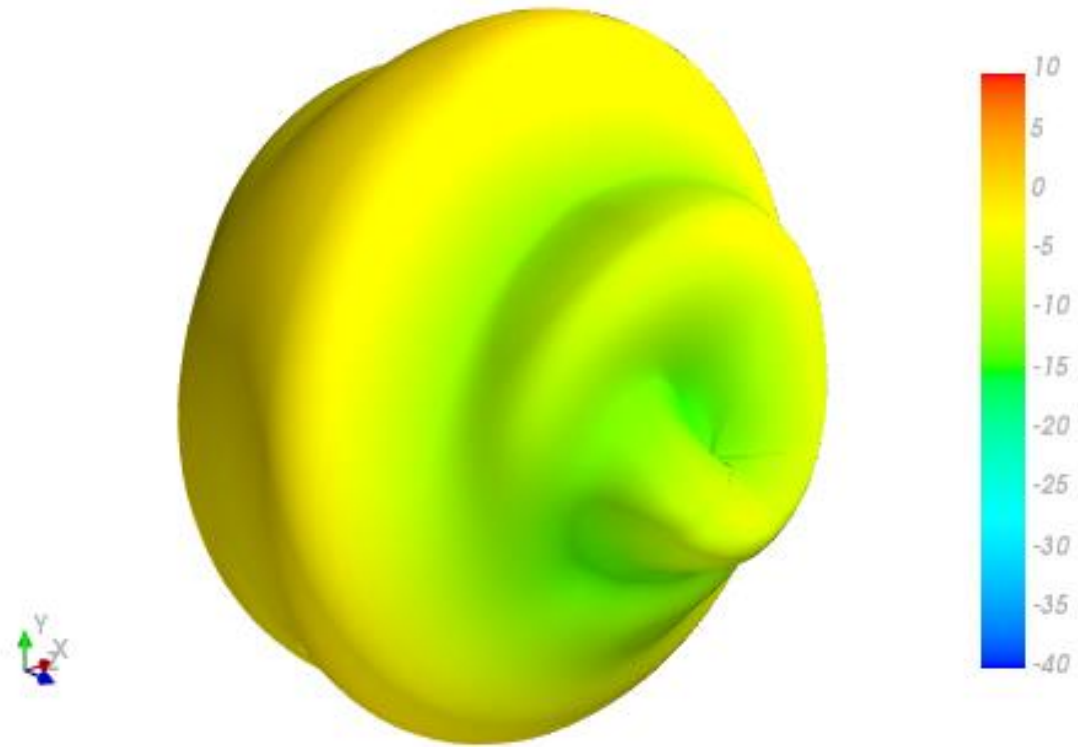

XY Plane

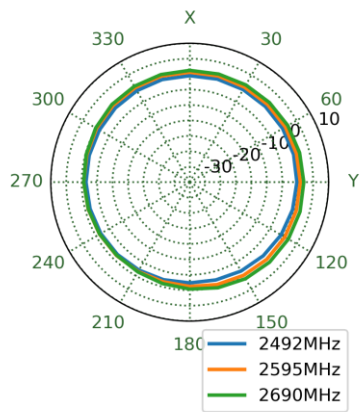

XZ Plane

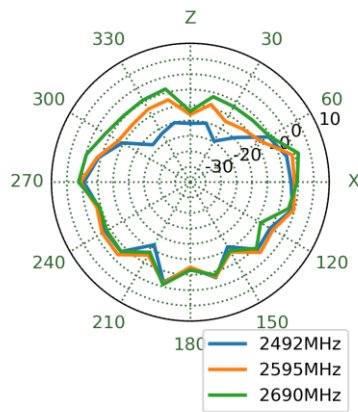

YZ Plane

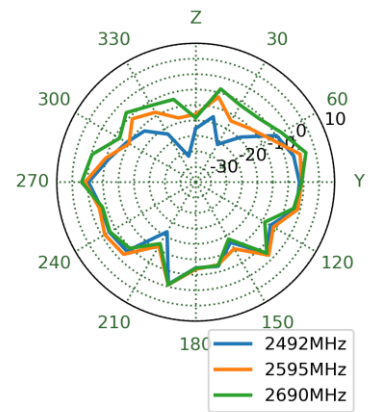

3550MHz

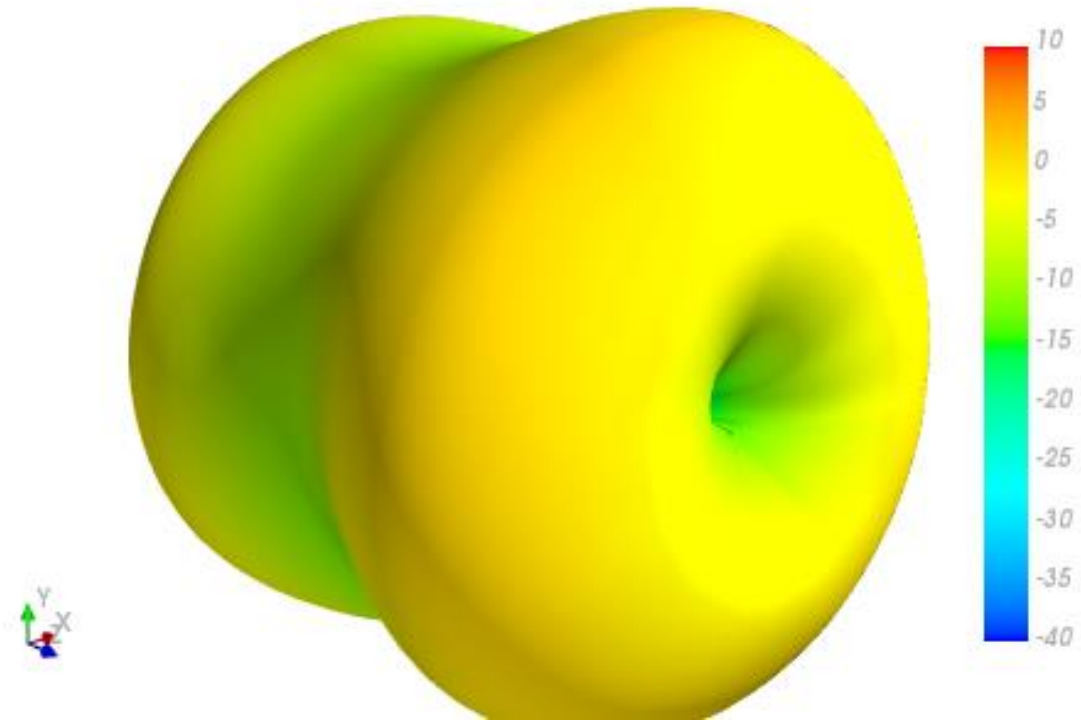

XY Plane

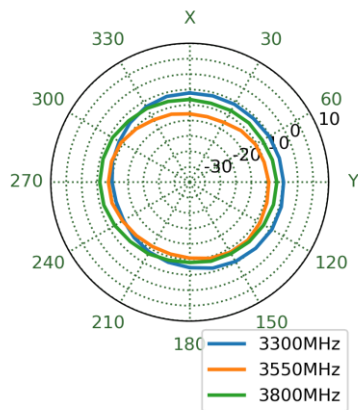

XZ Plane

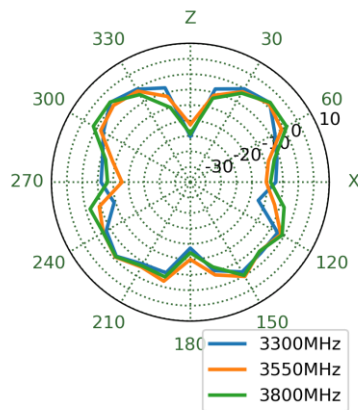

YZ Plane

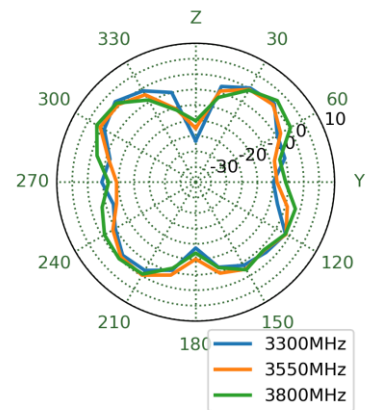



5530MHz

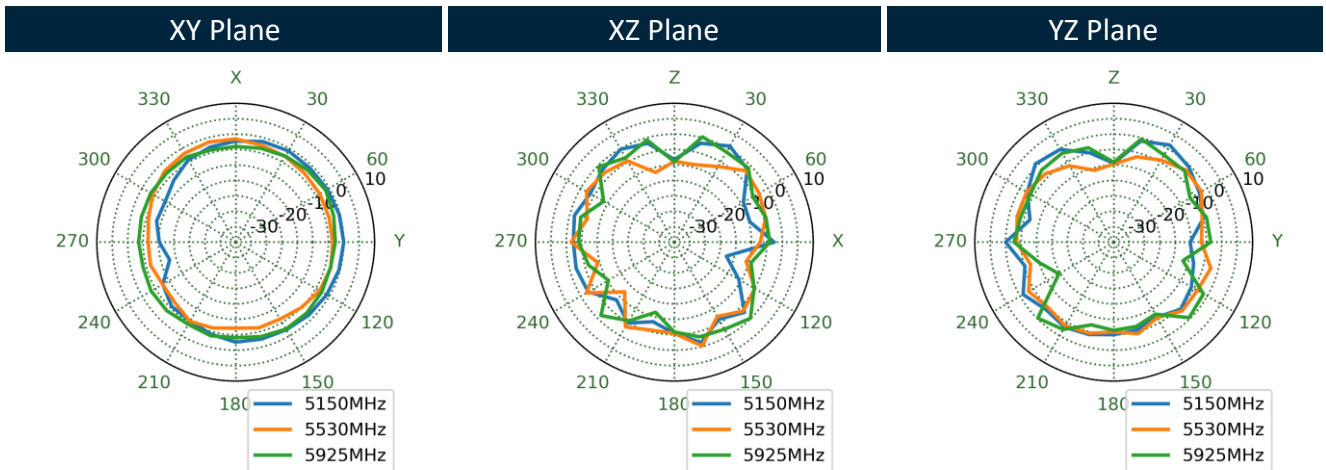
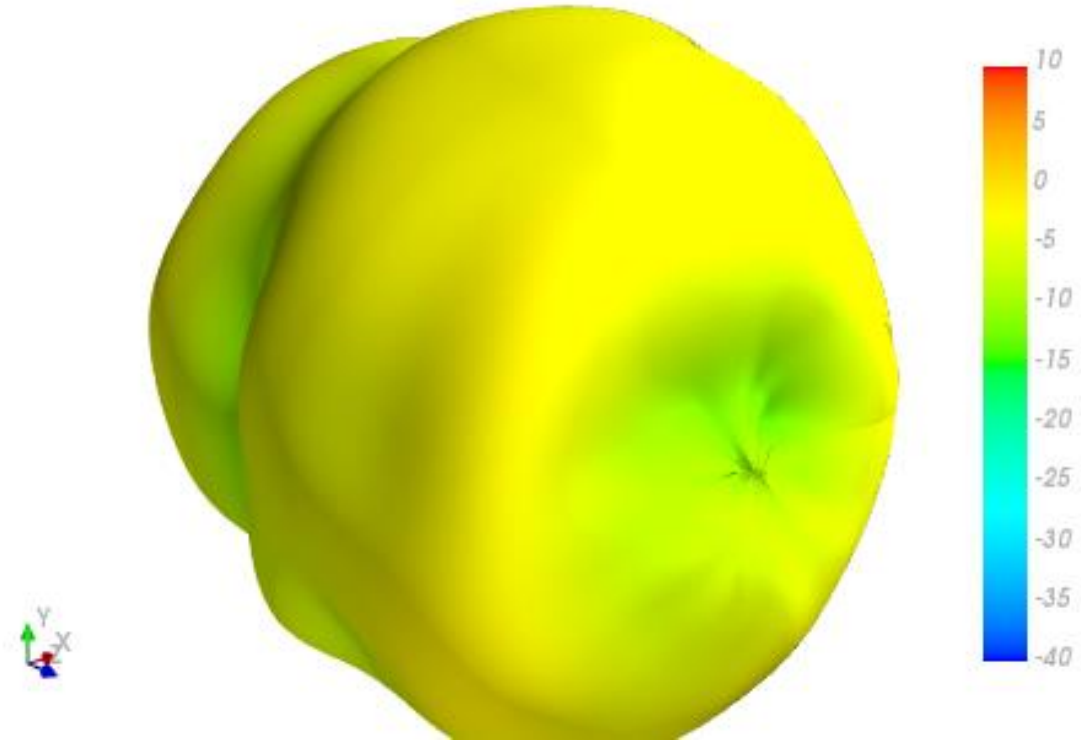

### 4.3 Test Setup

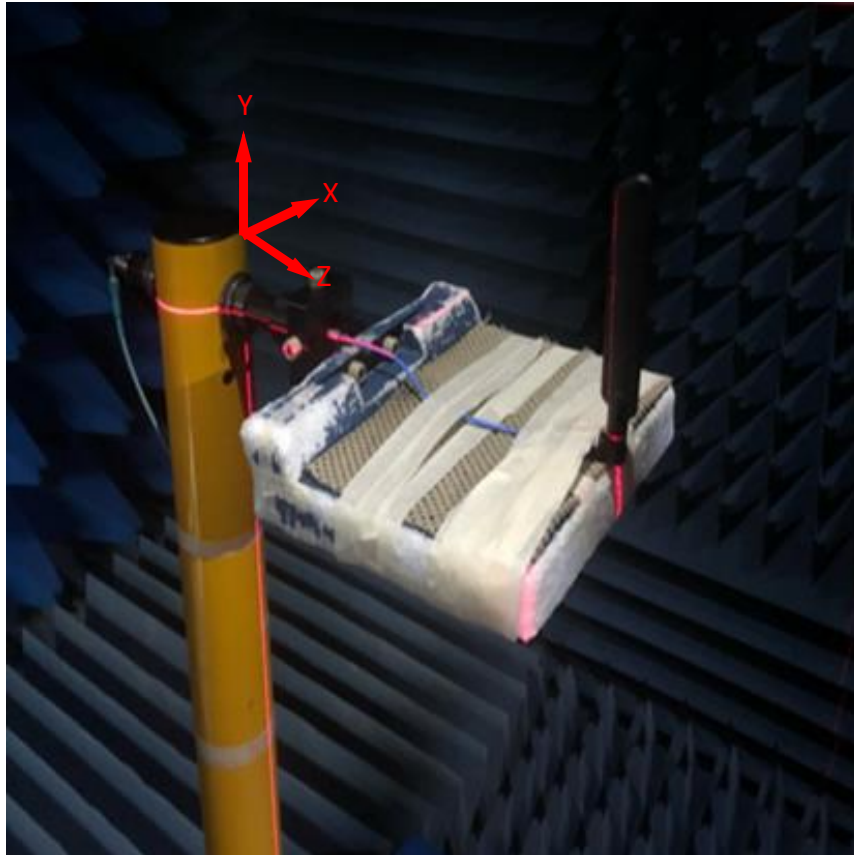

Bent Free Space

4.4 Bent Free Space 2D & 3D Radiation Patterns

652MHz

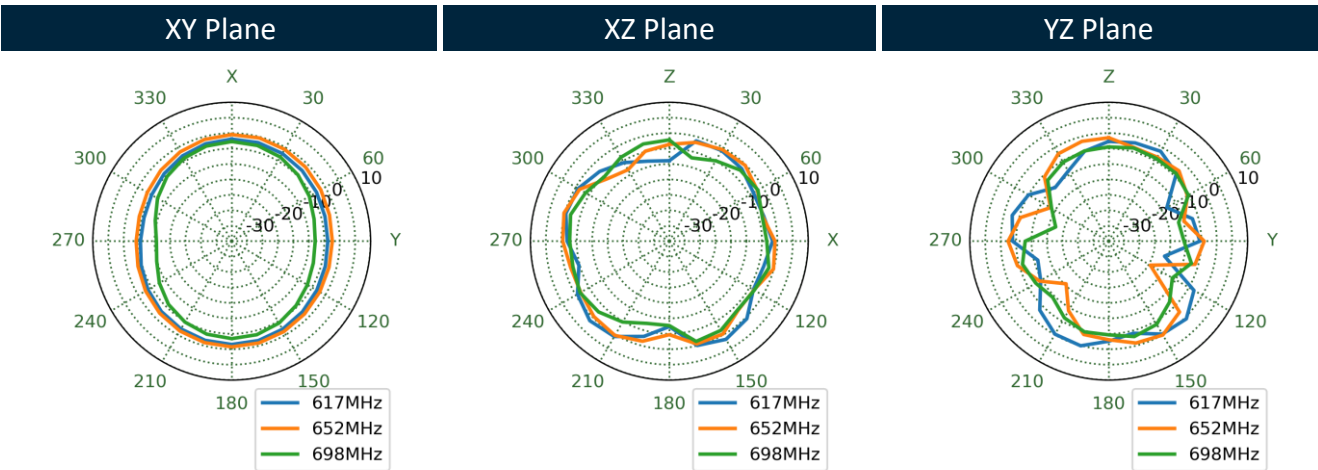
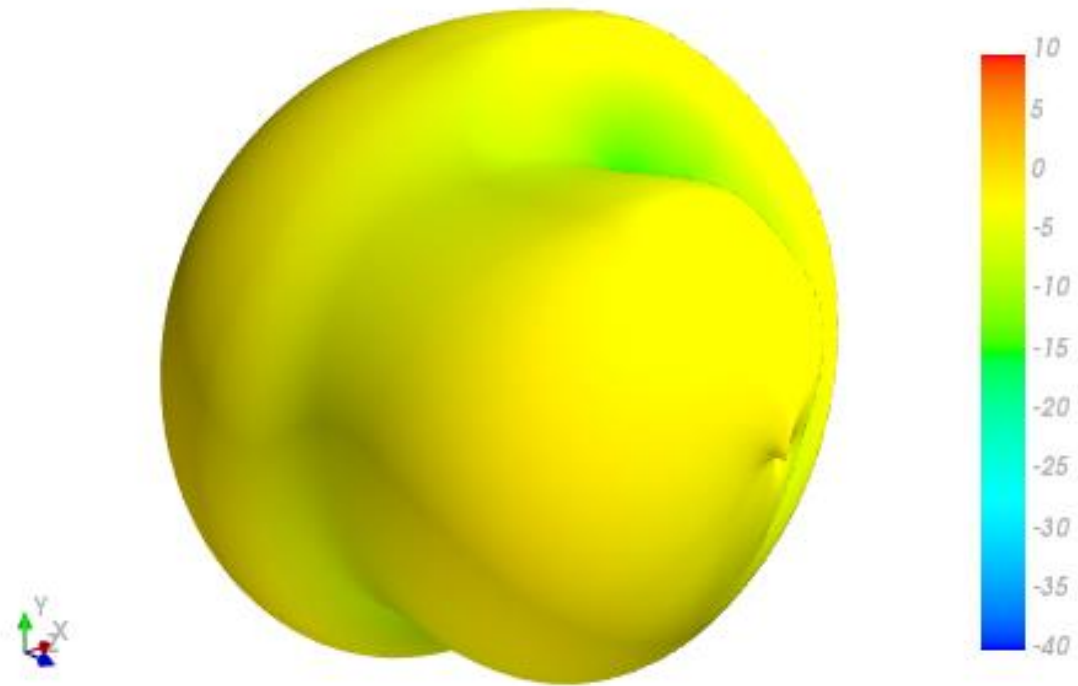

751MHz

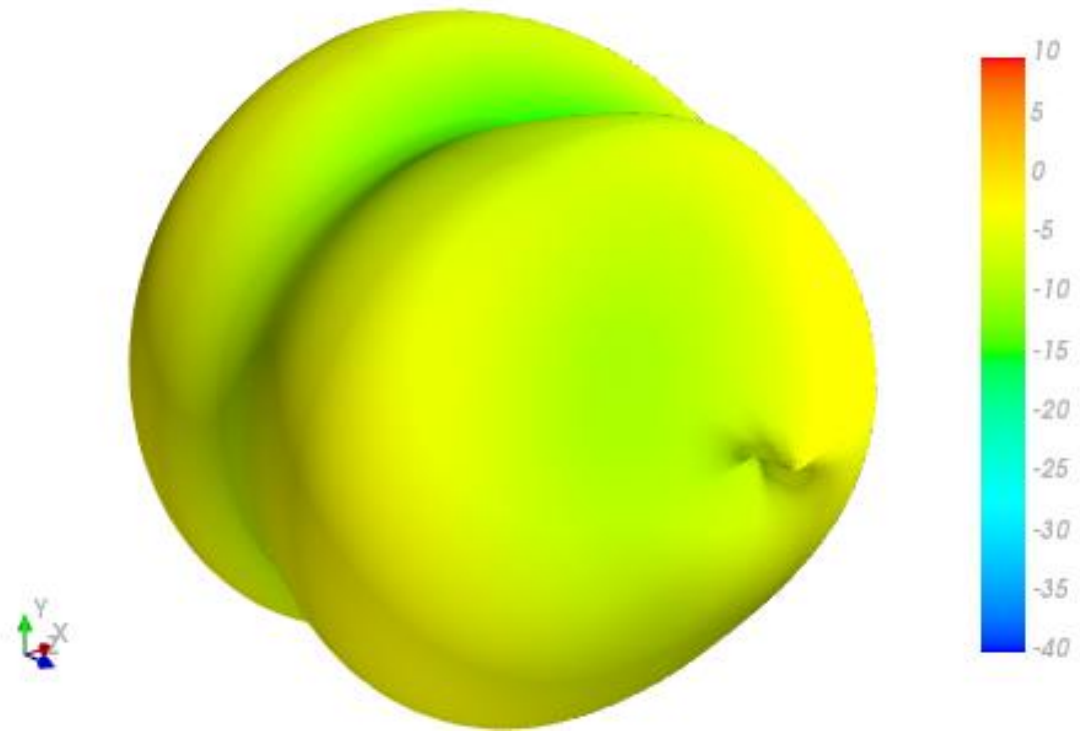

XY Plane

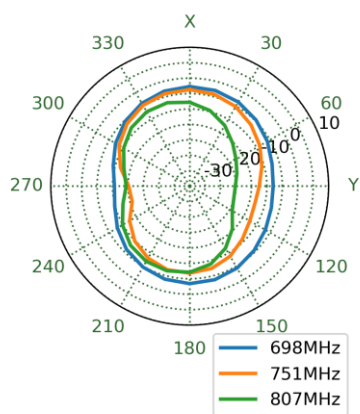

XZ Plane

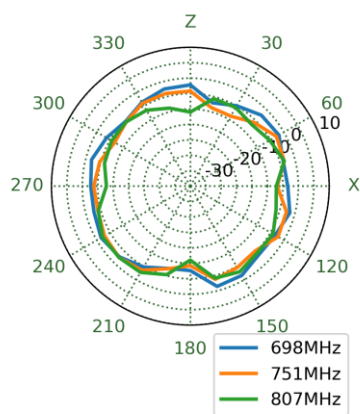

YZ Plane

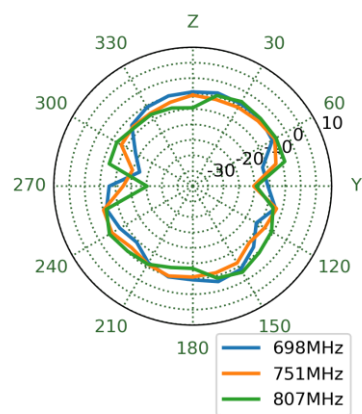

890MHz

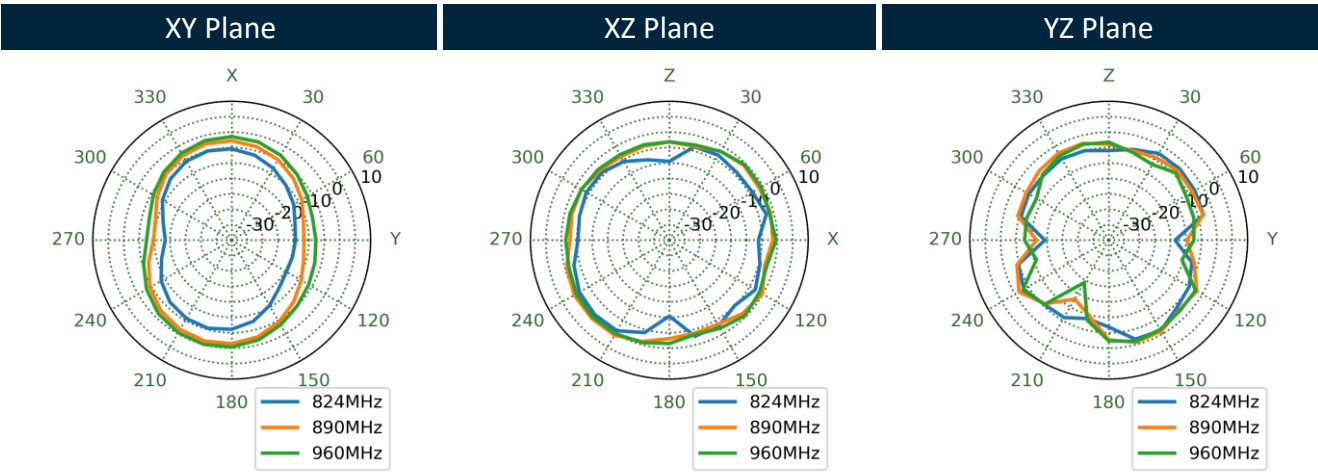
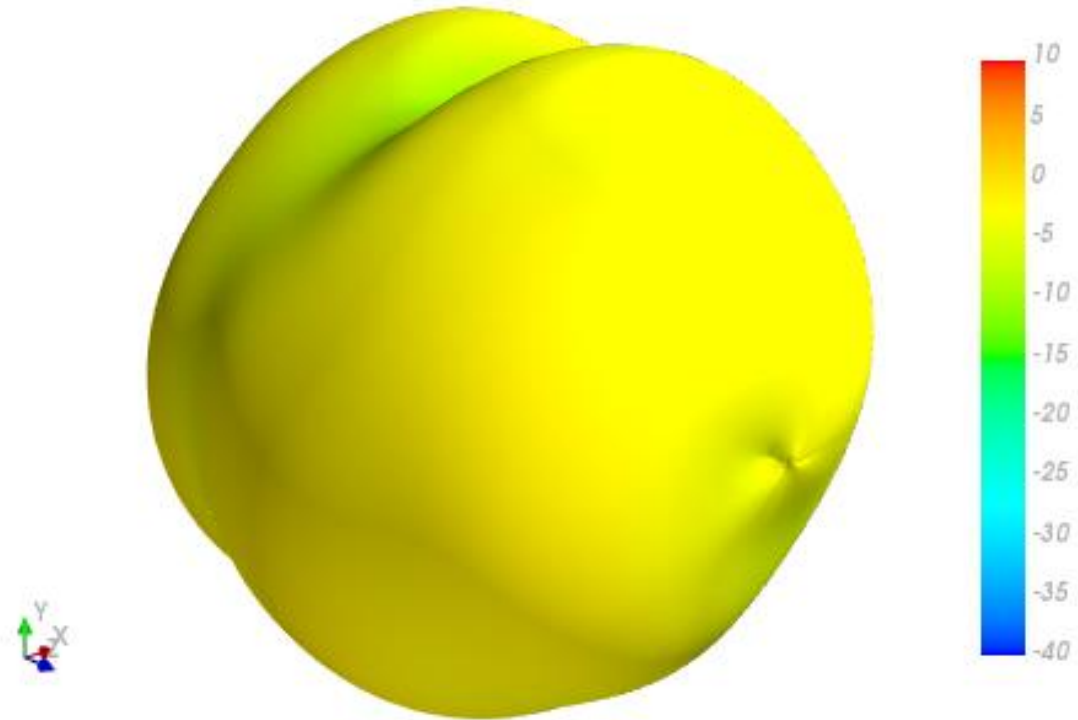

1470MHz

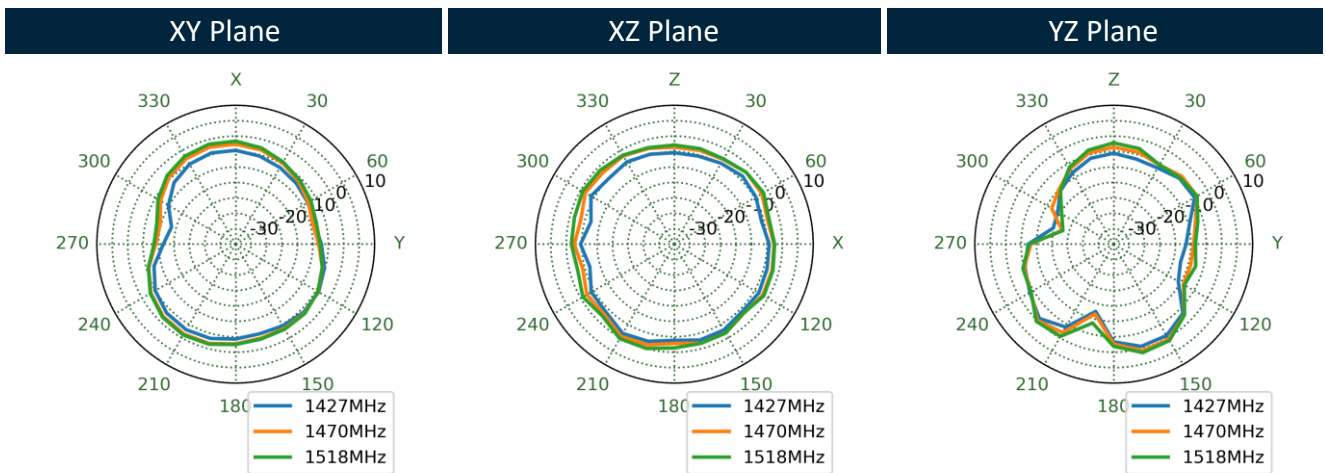
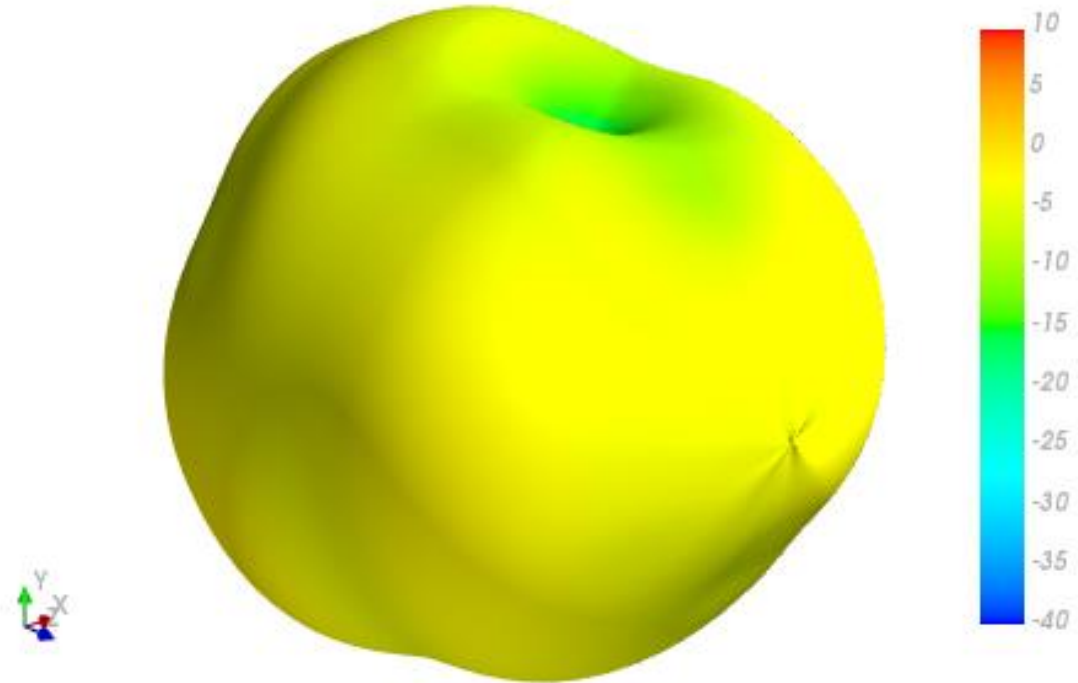

1805MHz

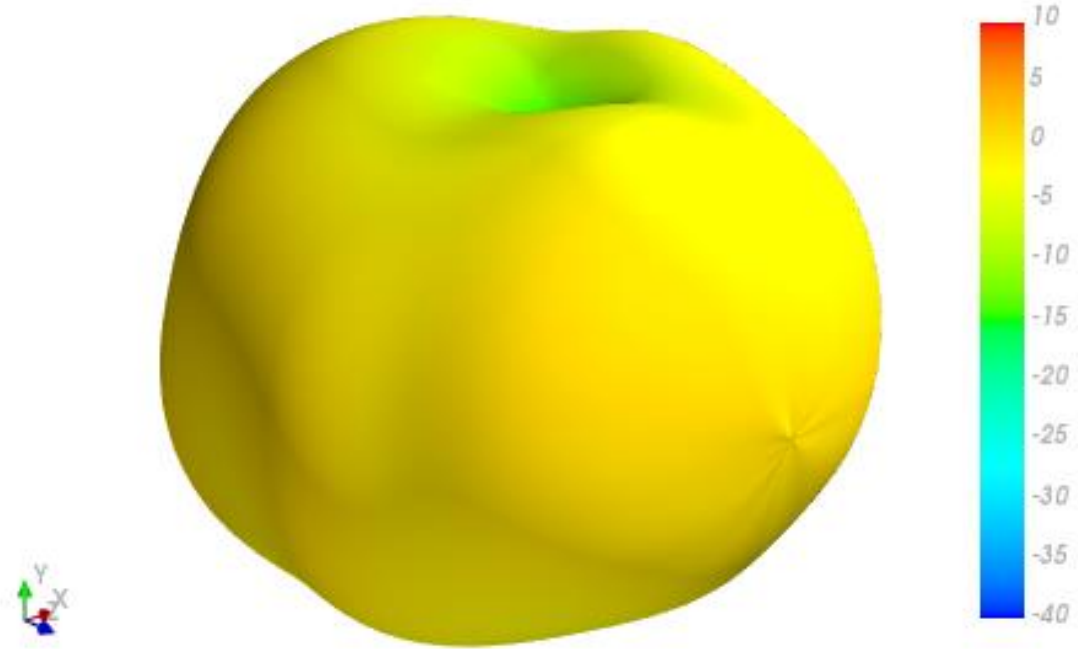

XY Plane

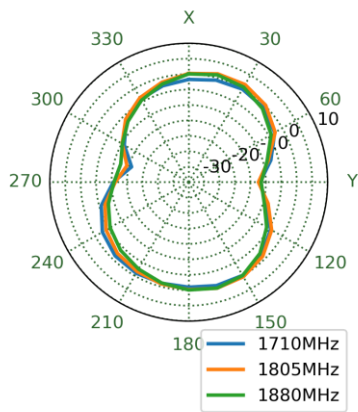

XZ Plane

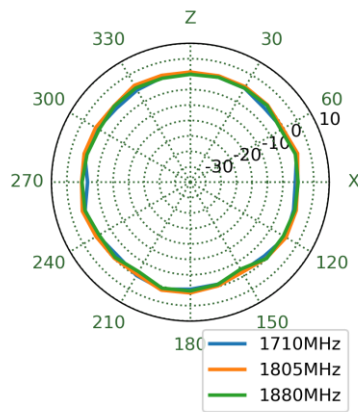

YZ Plane

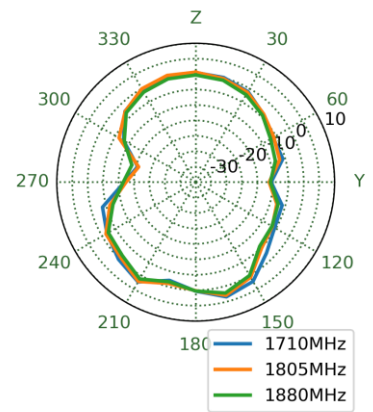



1920MHz

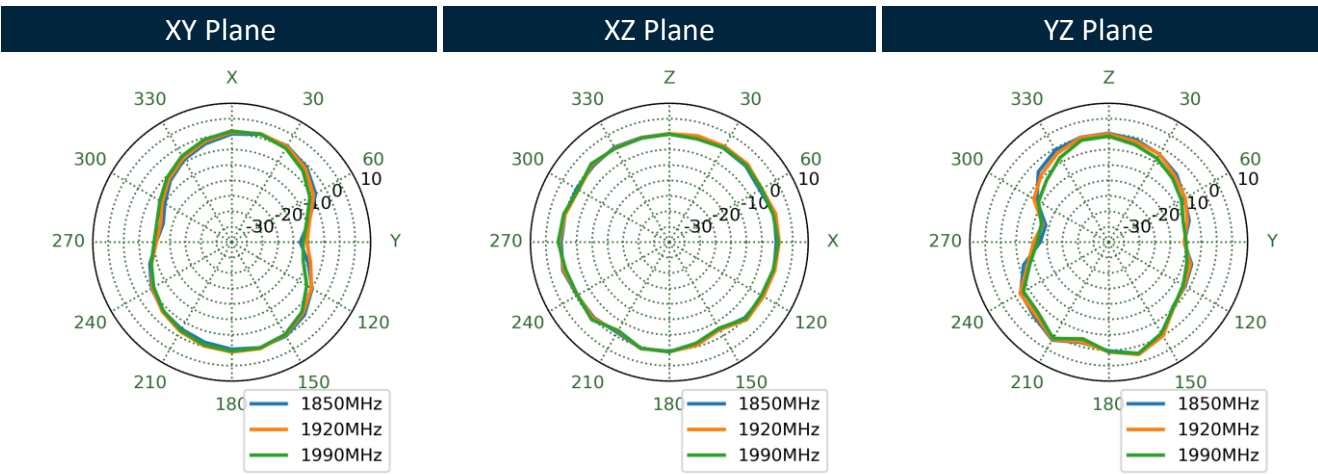
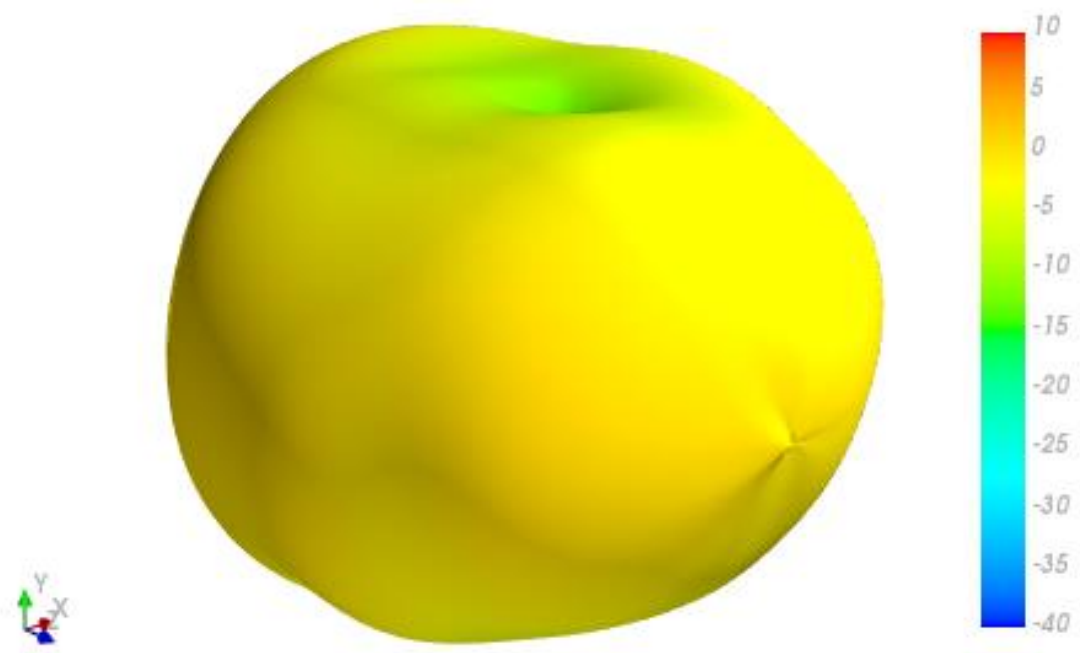

1990MHz

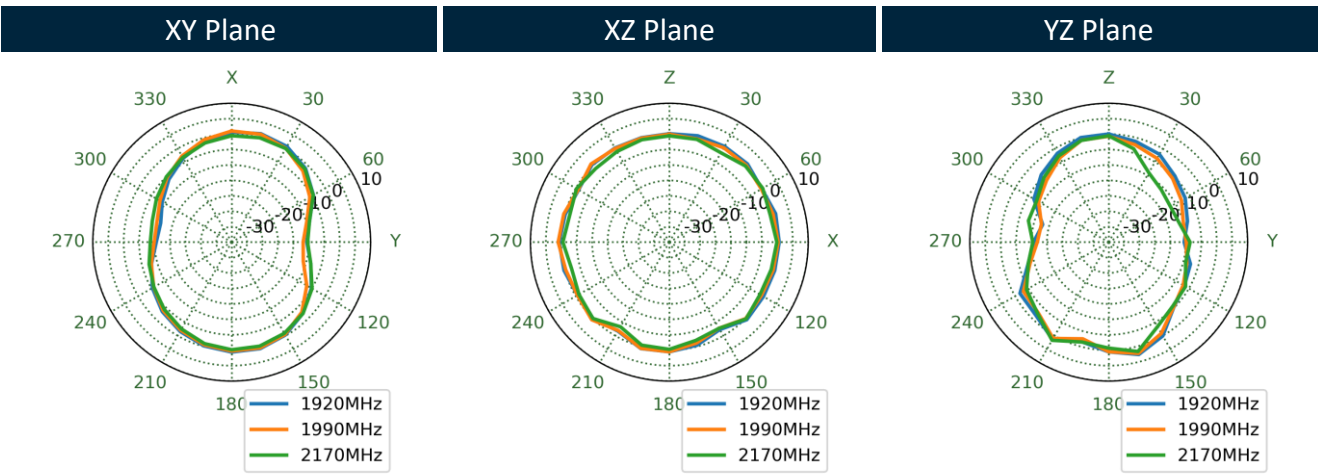
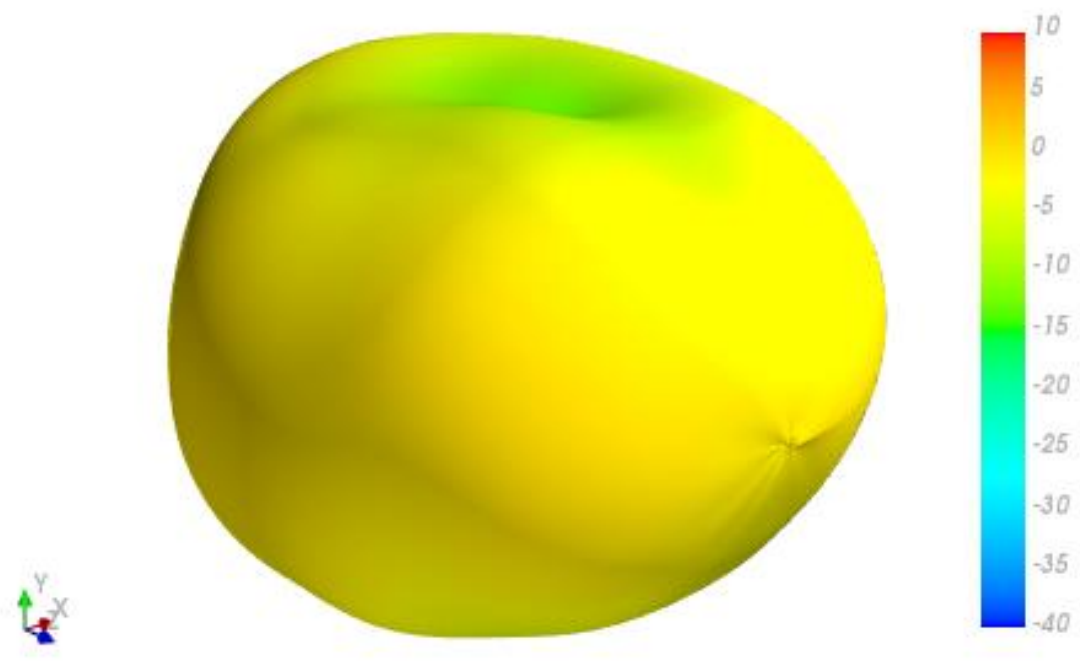

2595MHz

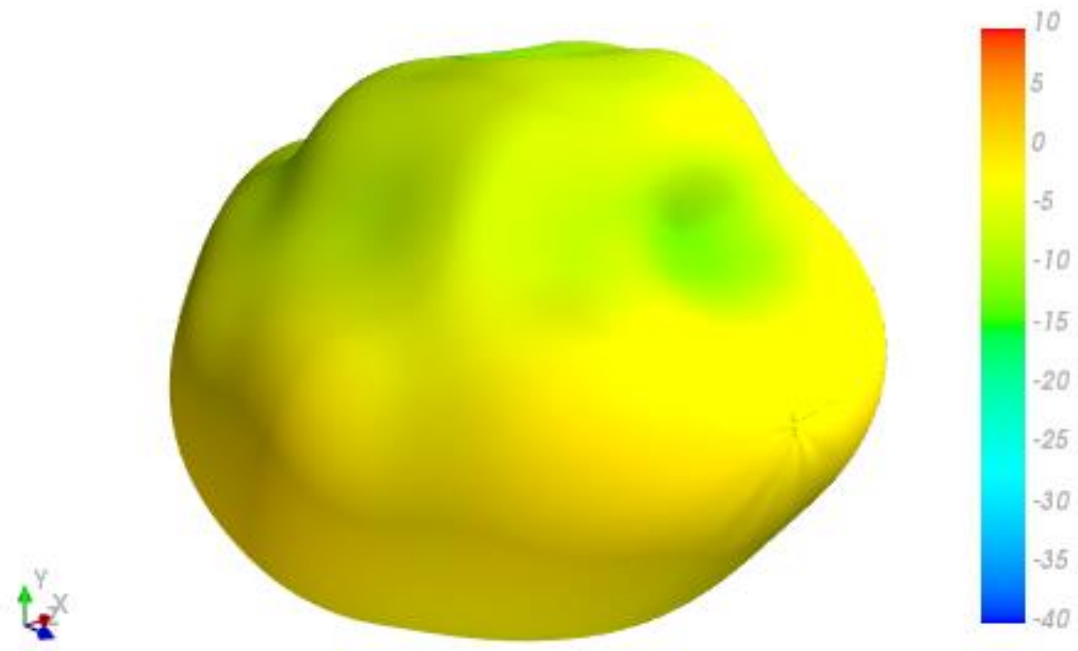

XY Plane

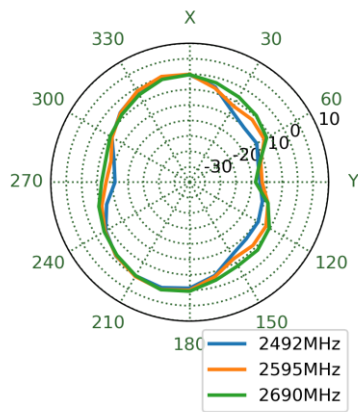

XZ Plane

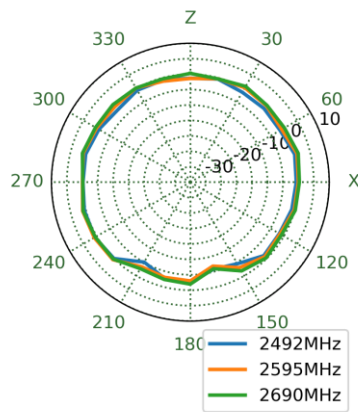

YZ Plane

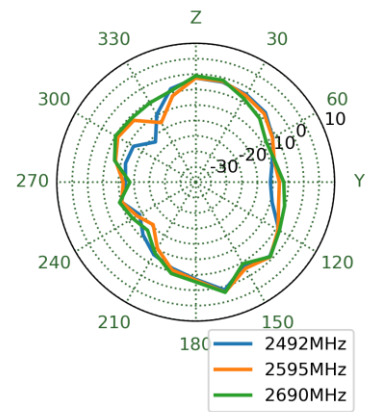

3550MHz

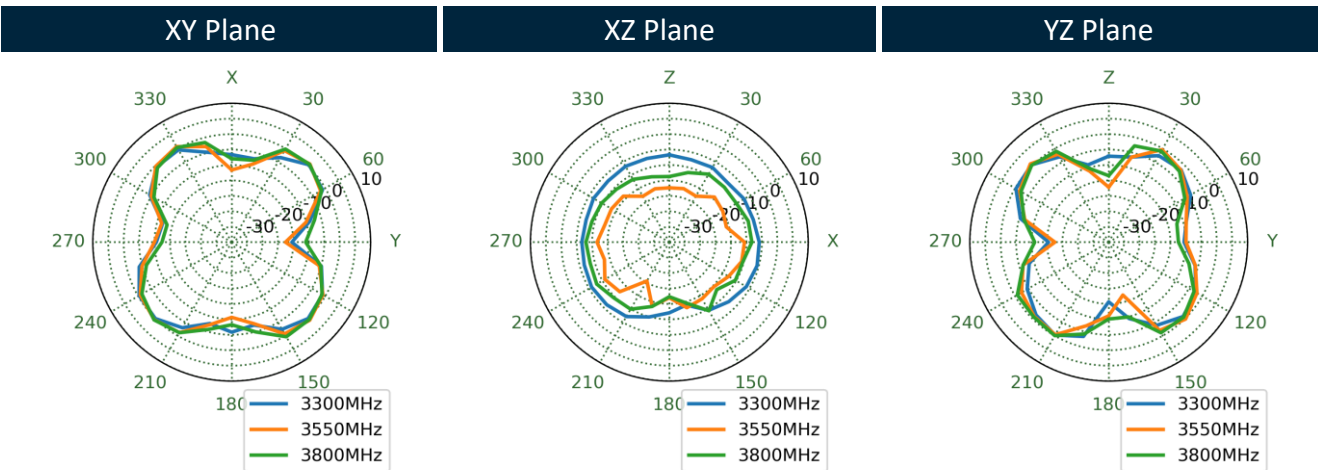
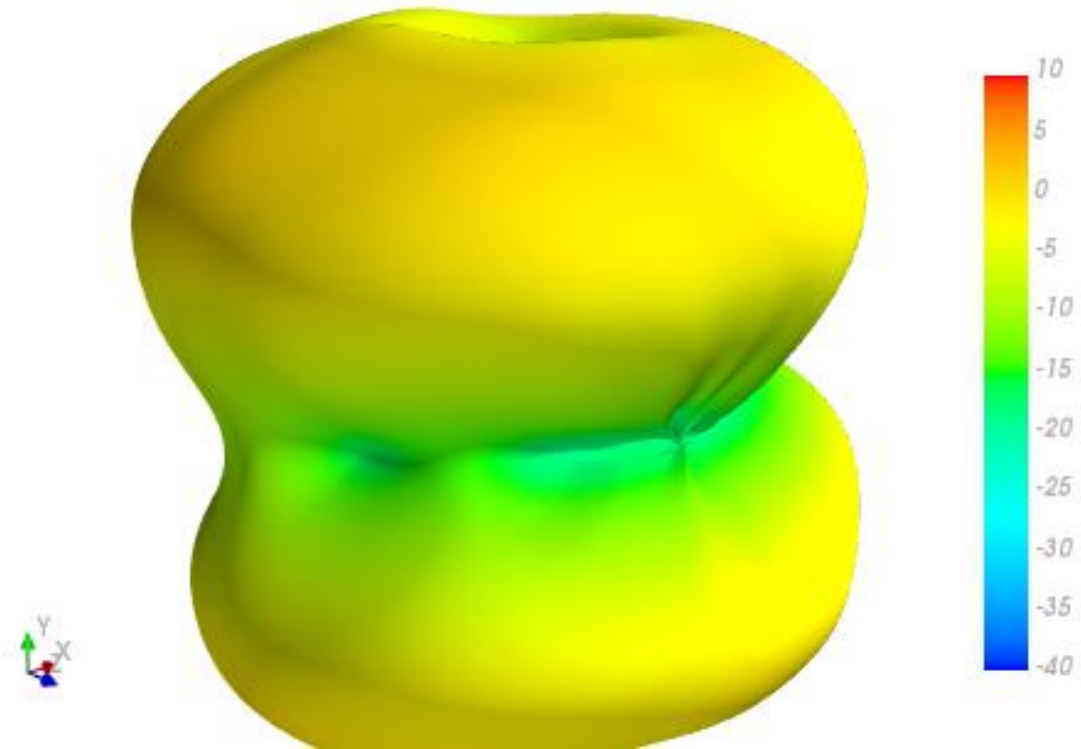

5530MHz

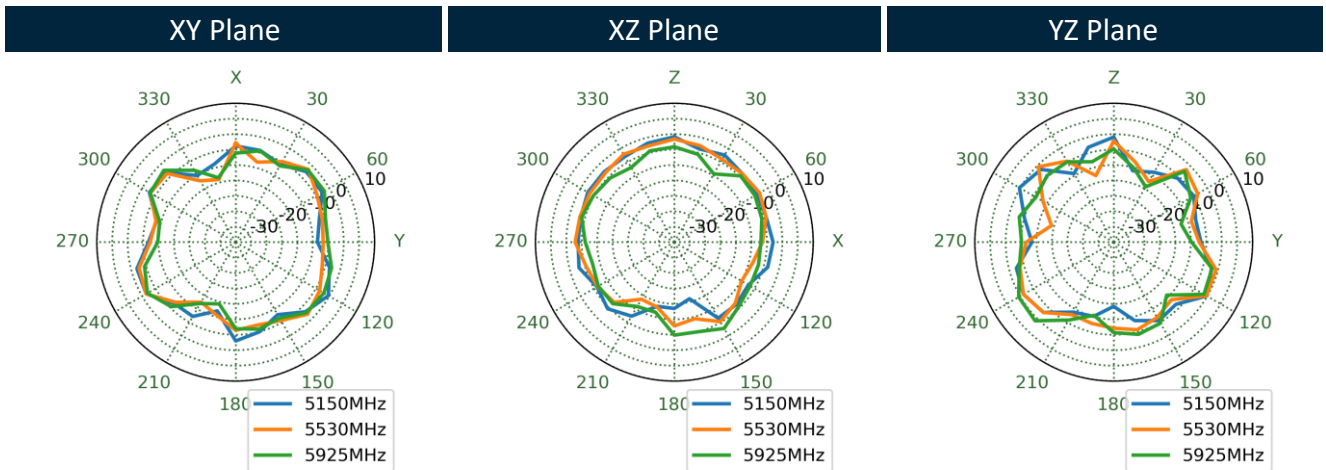
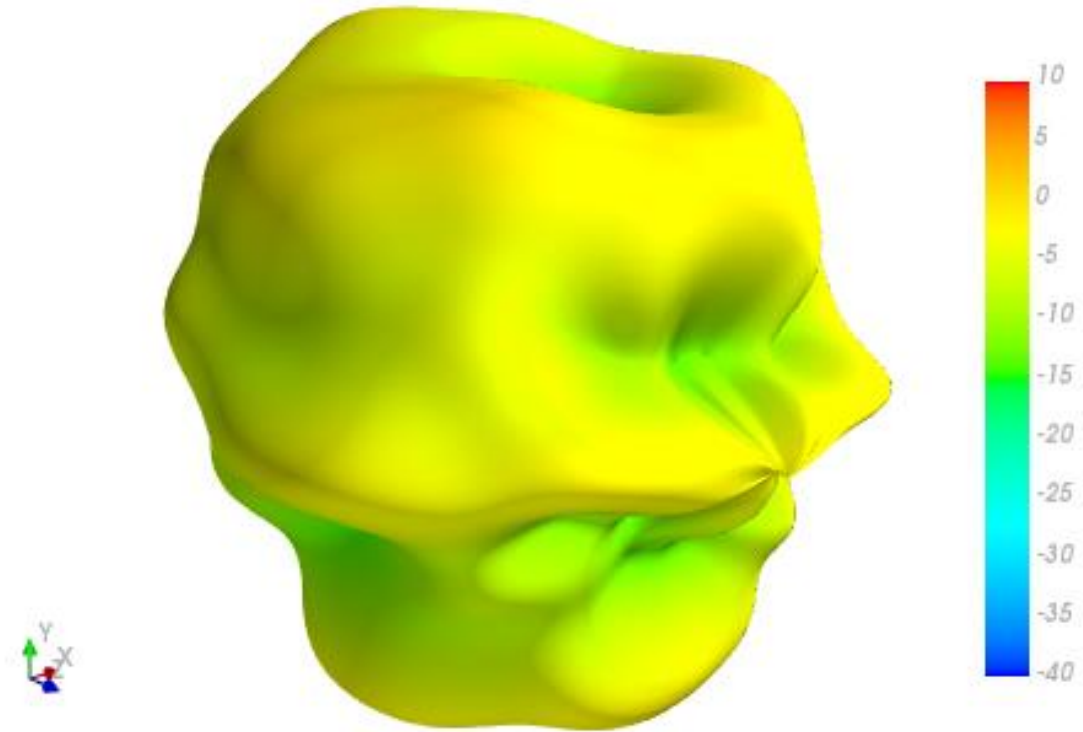

4.5 Test Setup

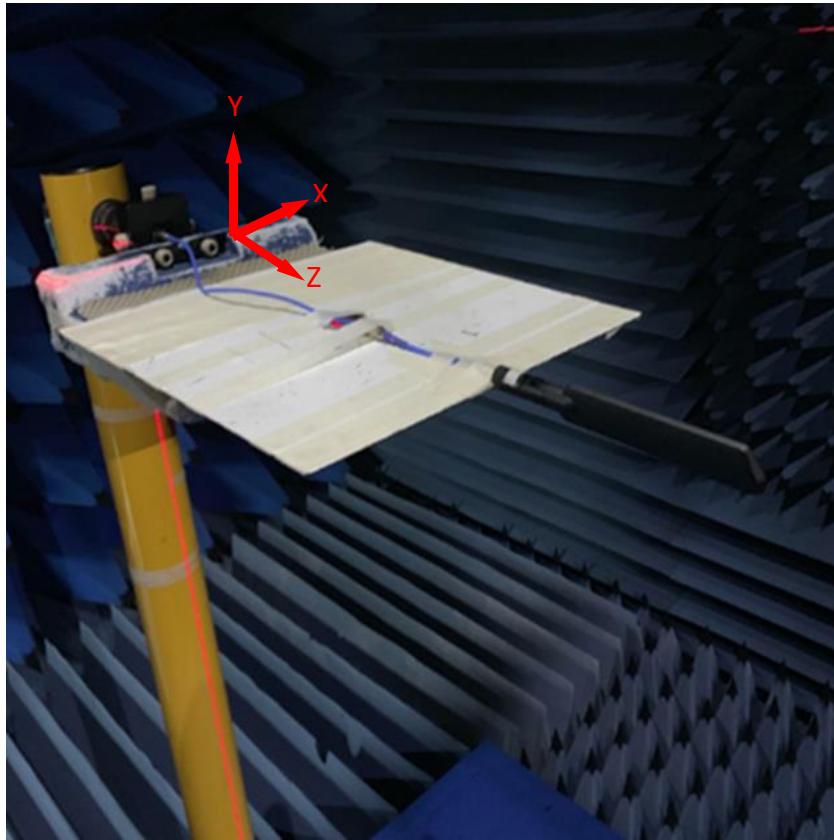

Straight 30x30cm Ground Plane Edge

## 4.6 Straight 30x30cm Ground Plane Edge 2D & 3D Radiation Patterns

652MHz

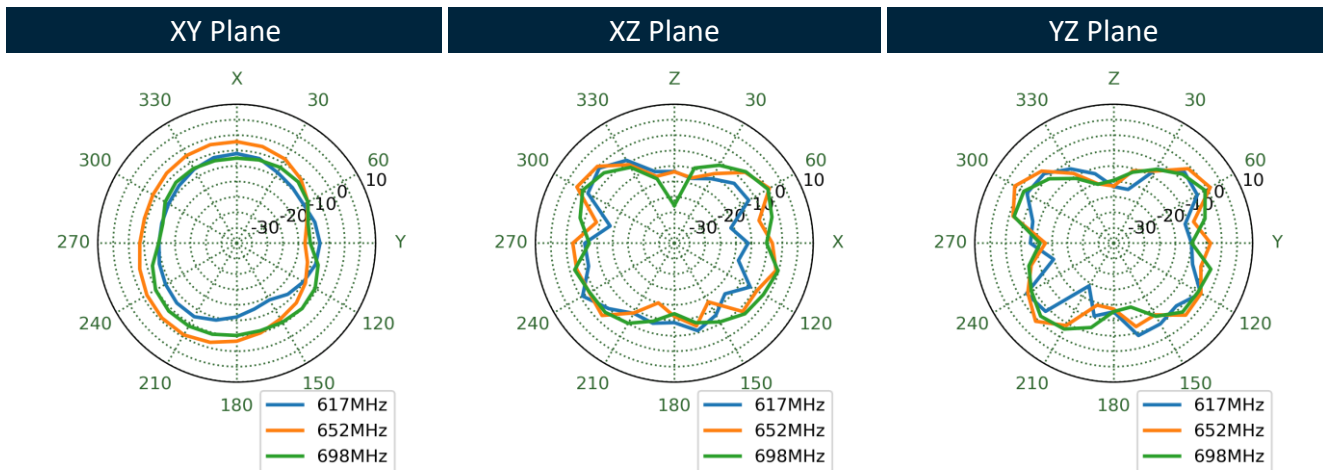
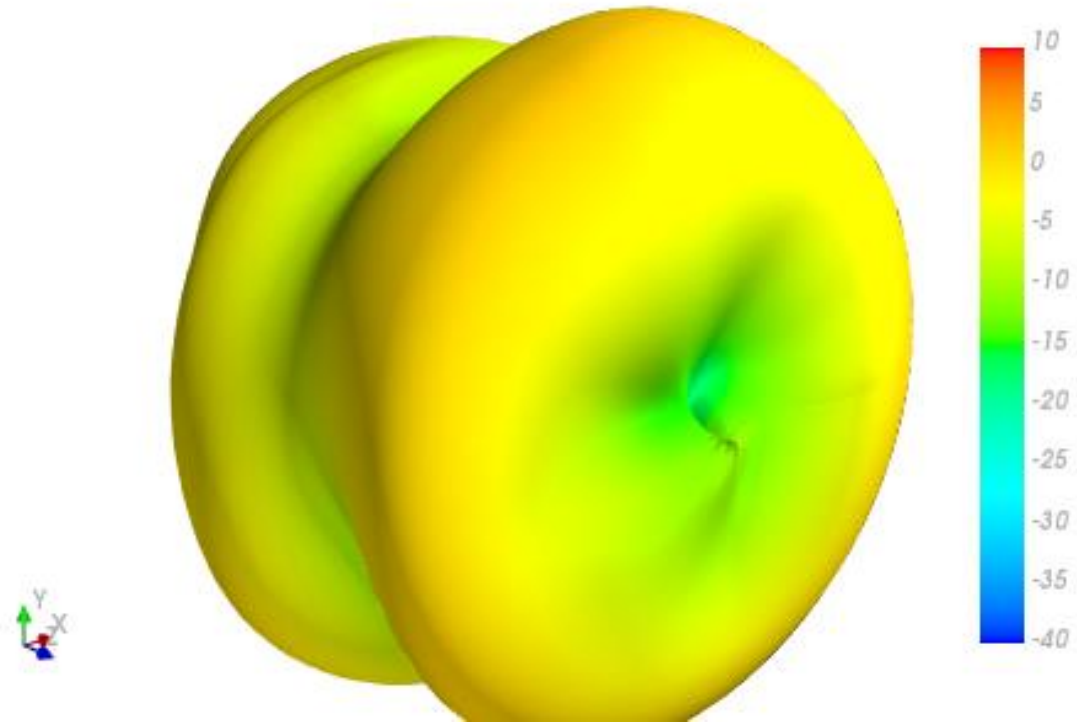



751MHz

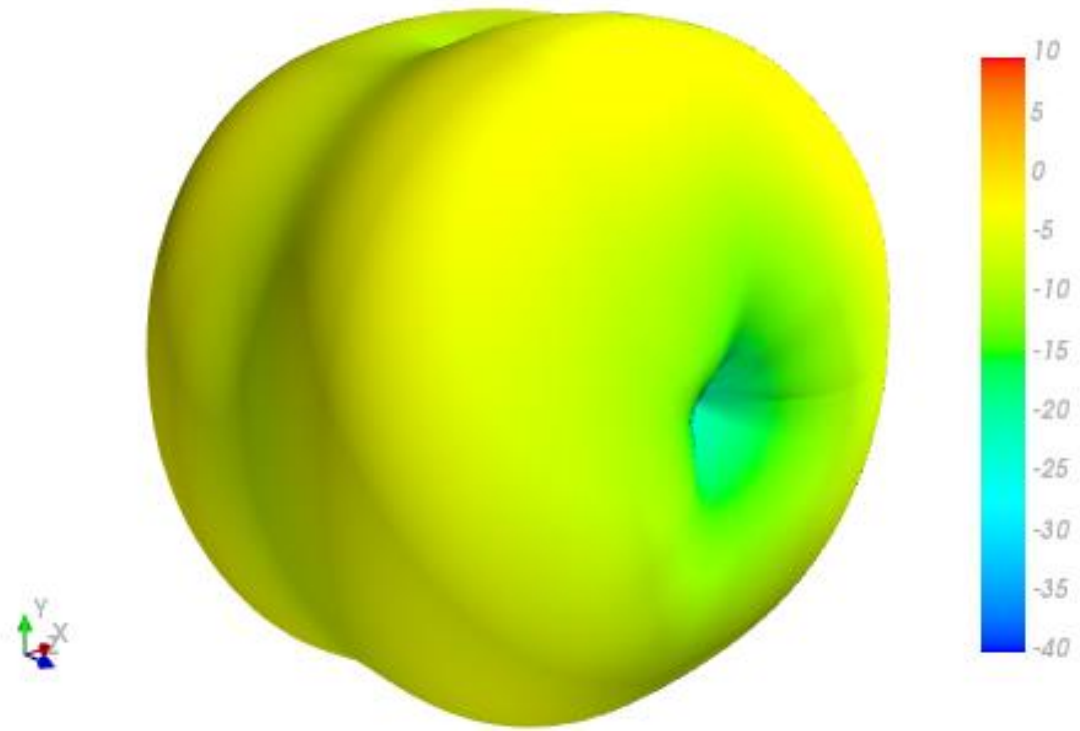

XY Plane

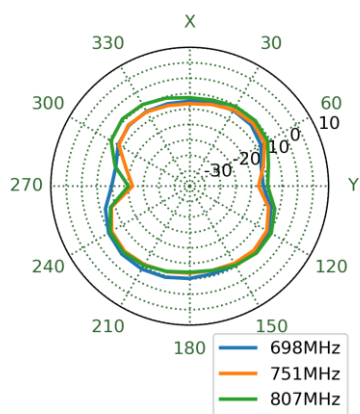

XZ Plane

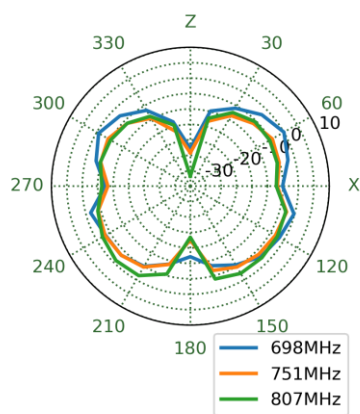

YZ Plane

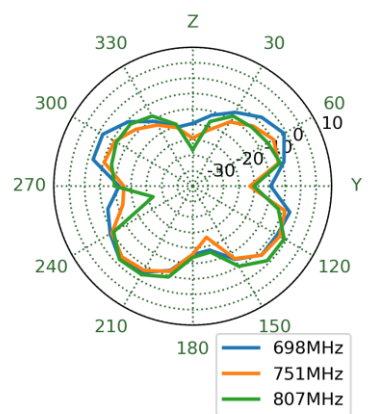

890MHz

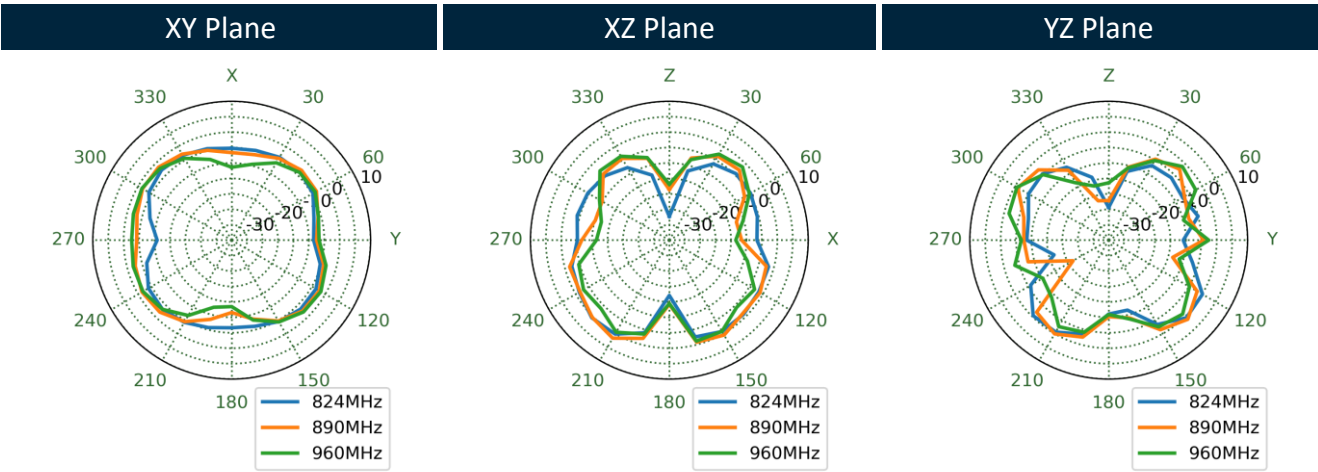
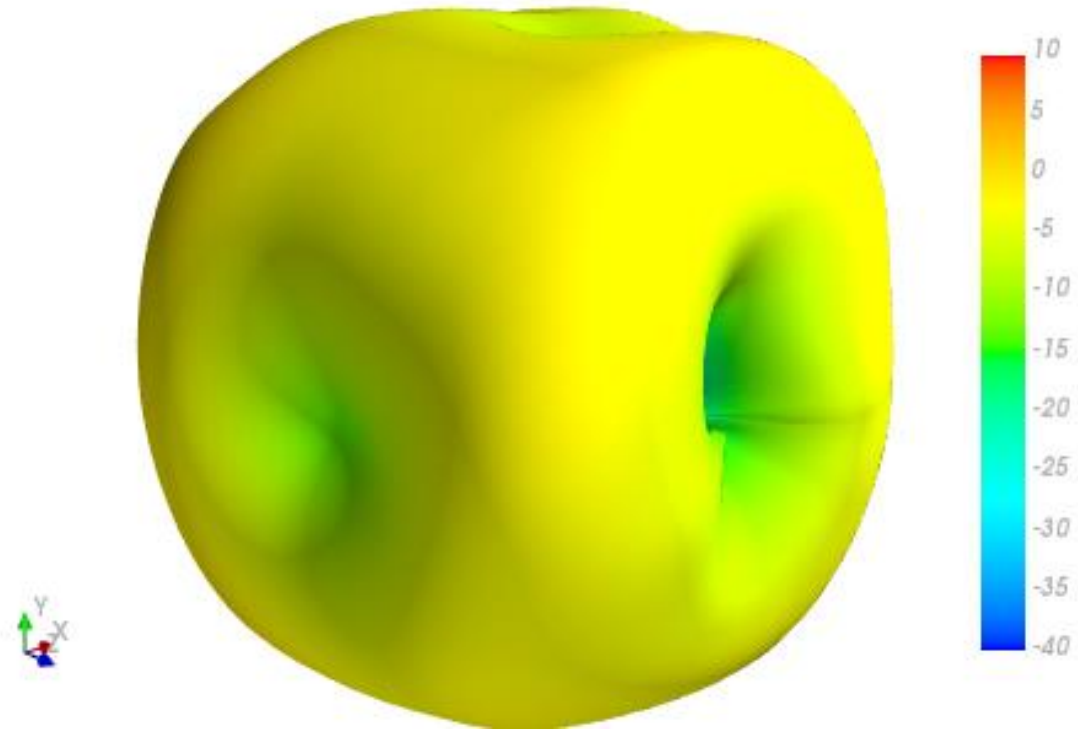

1470MHz

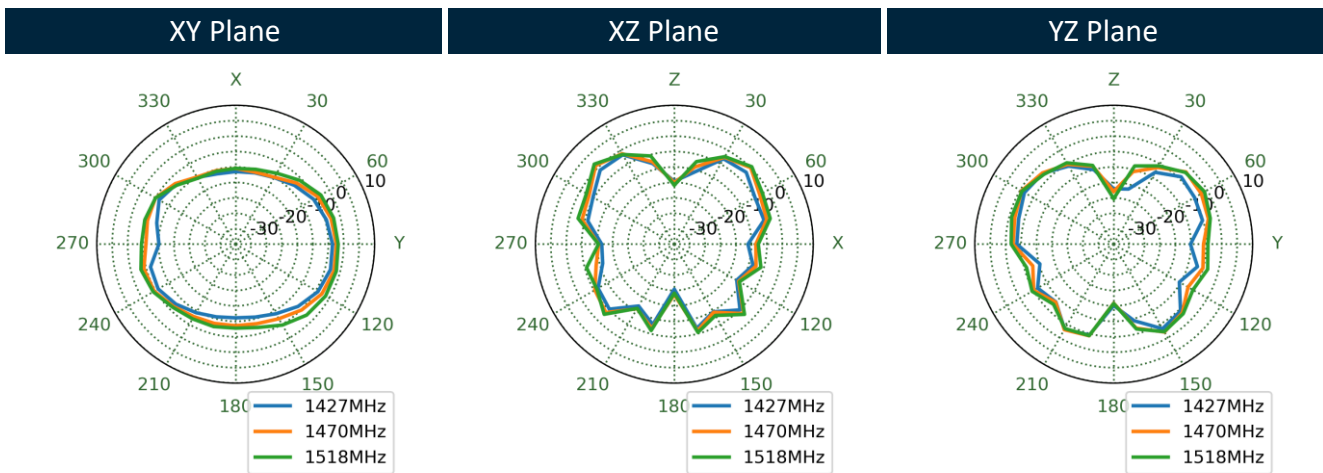
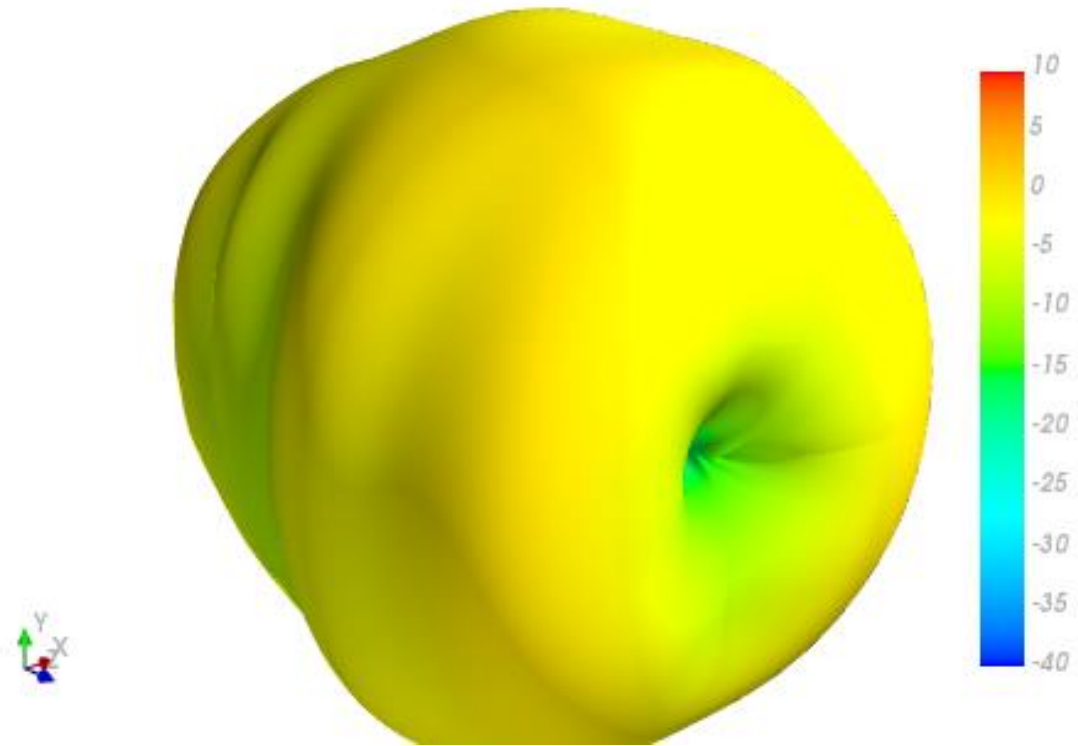

1805MHz

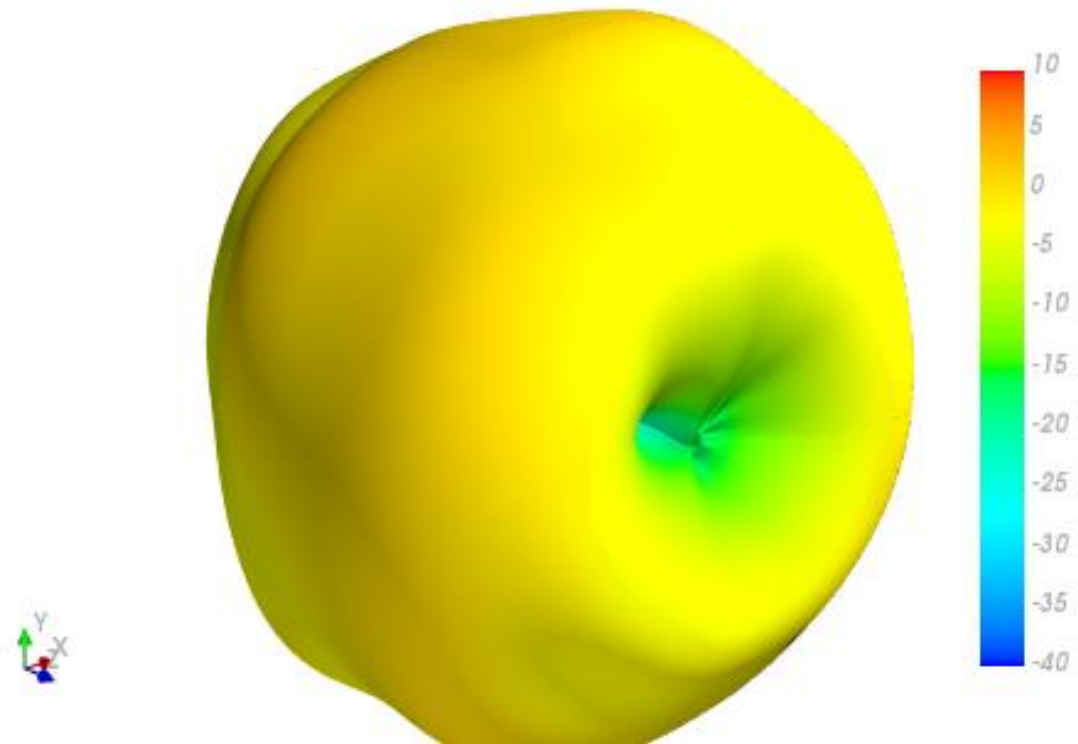

XY Plane      XZ Plane      YZ Plane

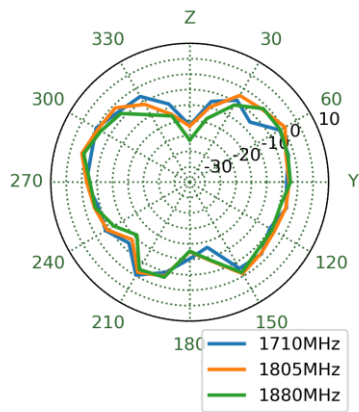
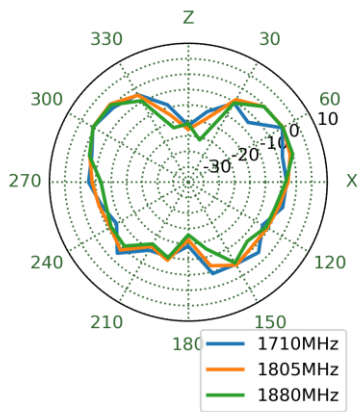
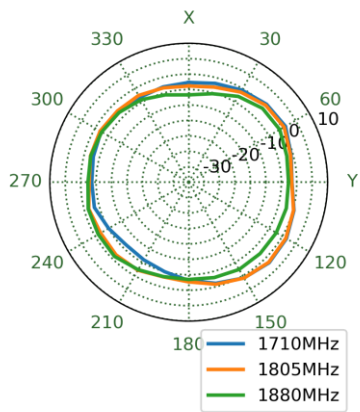

1920MHz

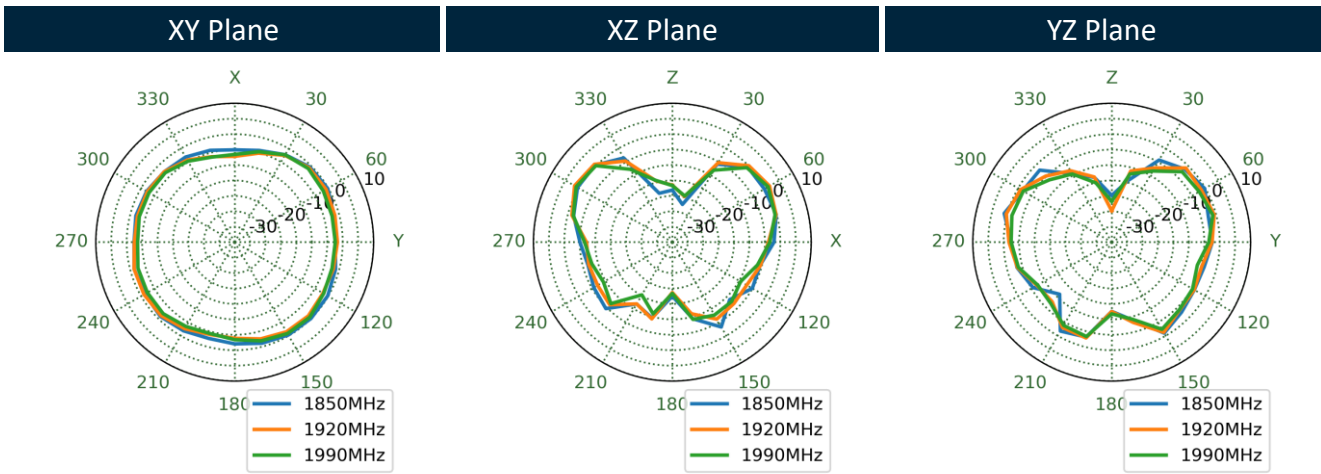
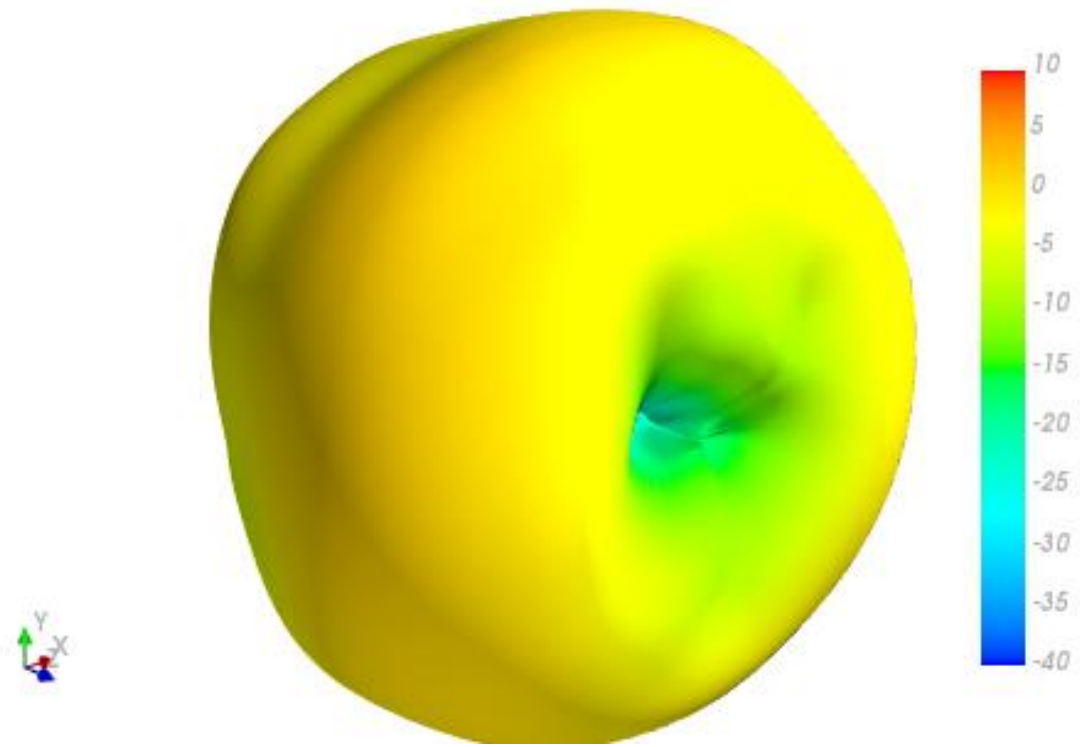

1990MHz

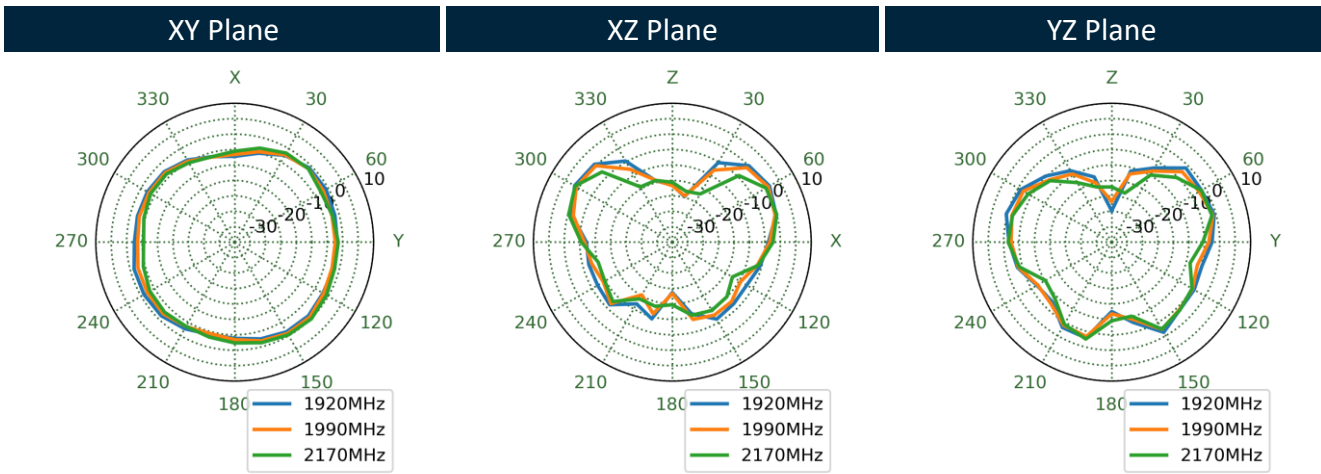
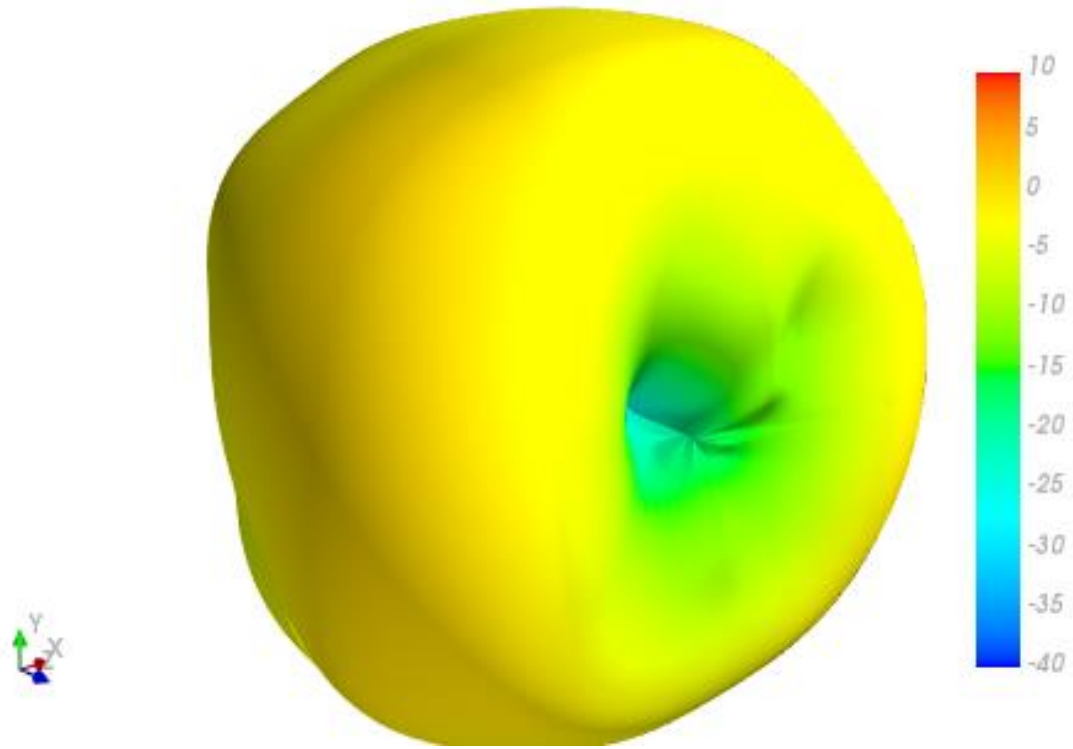

2595MHz

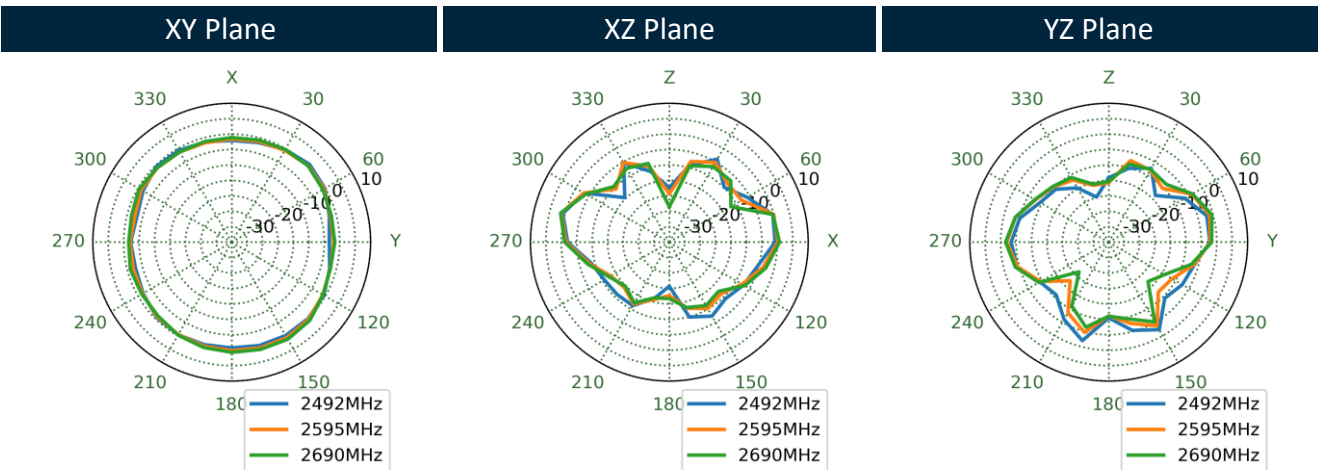
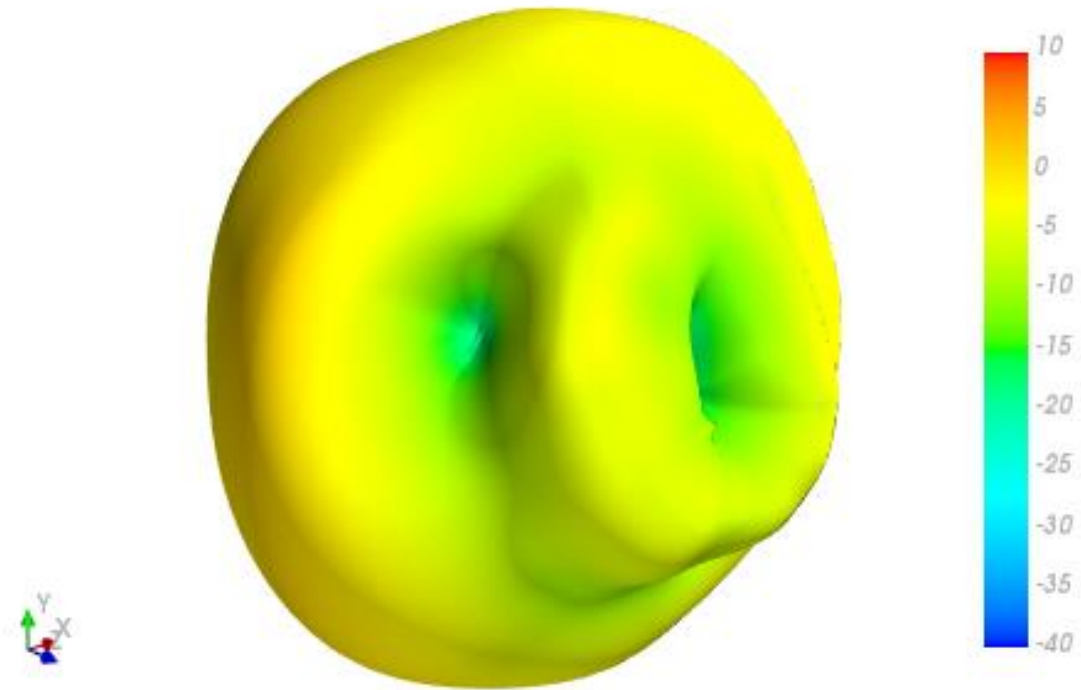



3550MHz

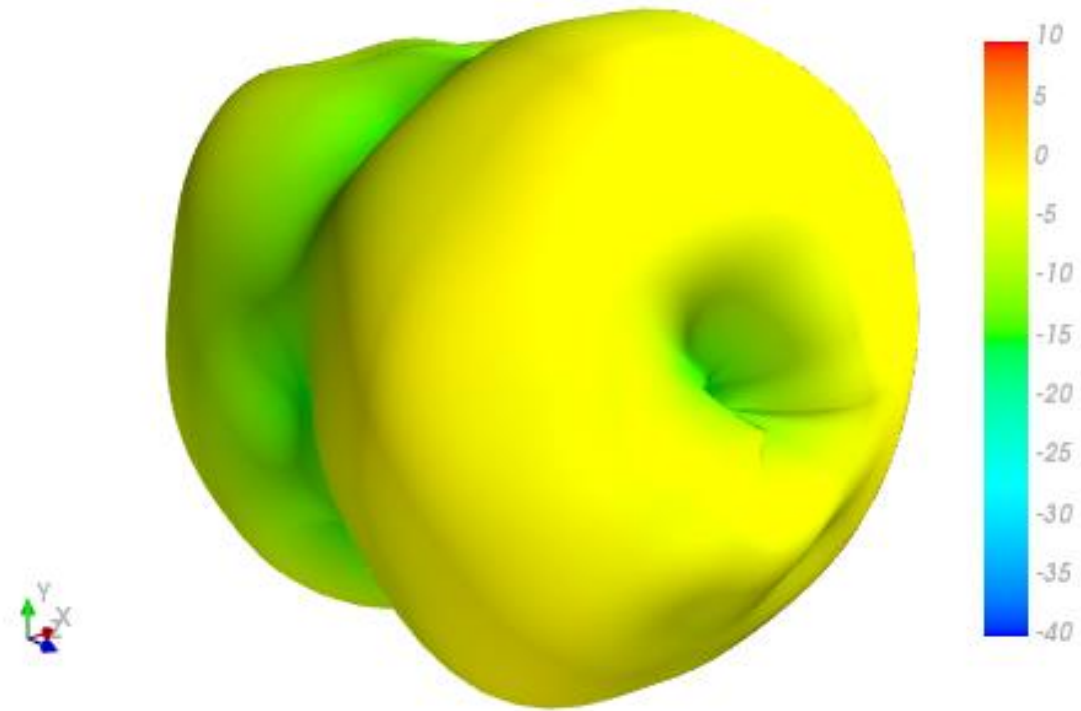

XY Plane

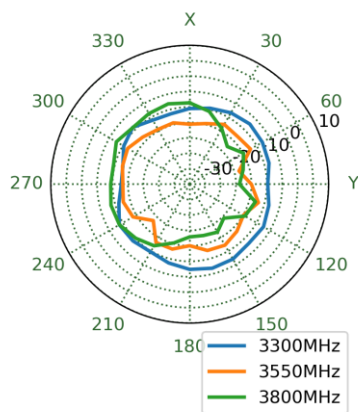

XZ Plane

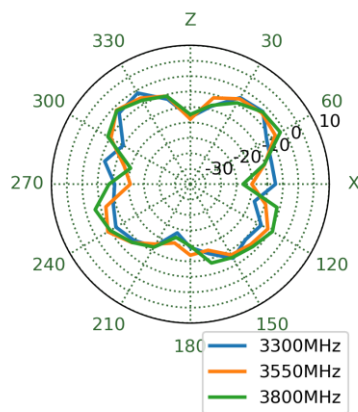

YZ Plane

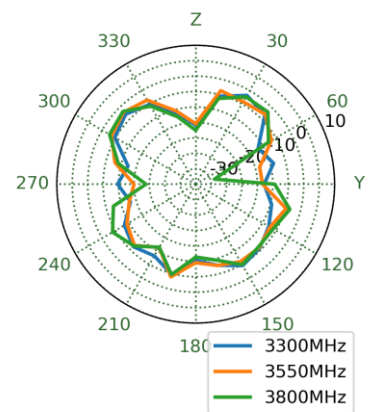

5530MHz

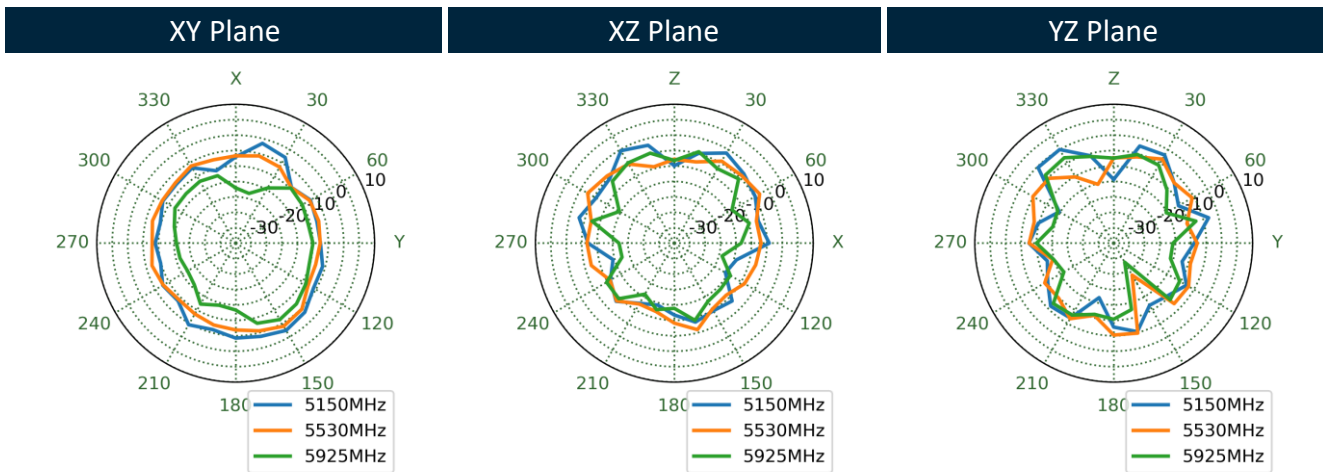
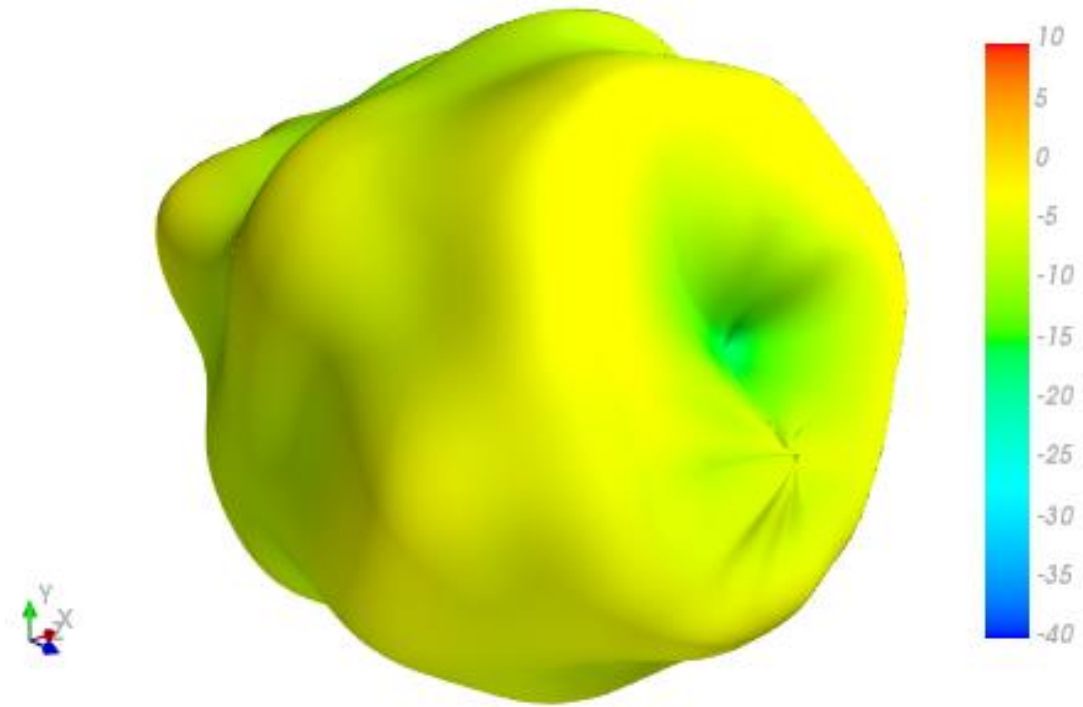

4.7 Test Setup



Bent 30x30cm Ground Plane Edge

4.8 Bent 30x30cm Ground Plane Edge 2D & 3D Radiation Patterns

652MHz

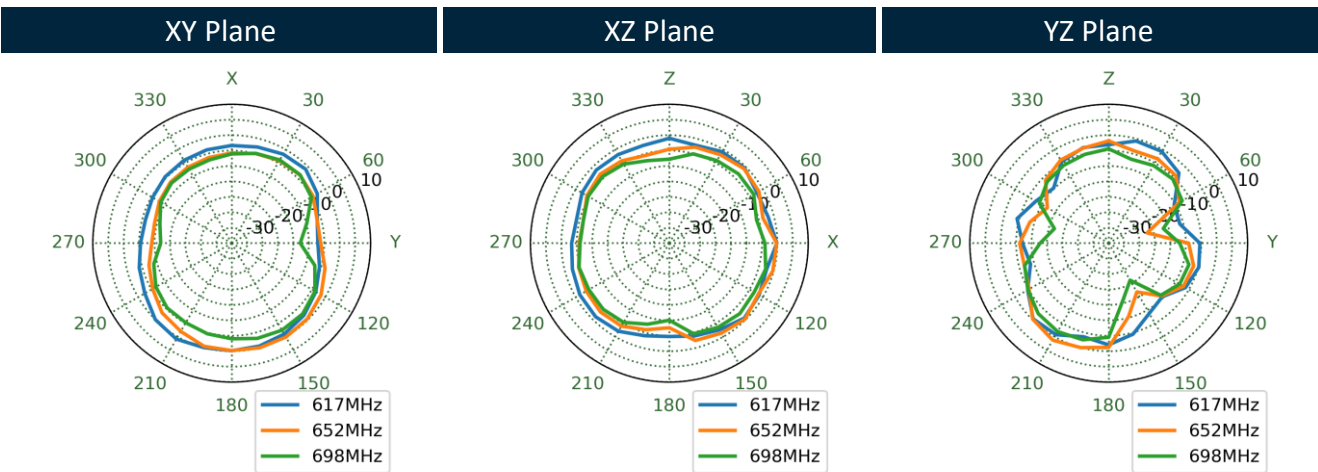
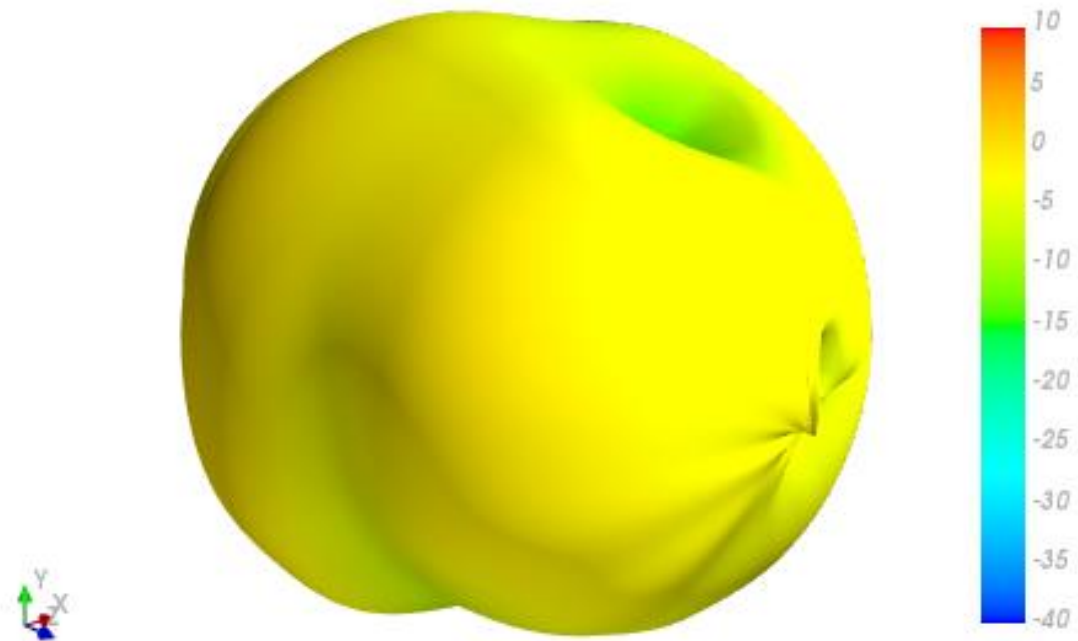

751MHz

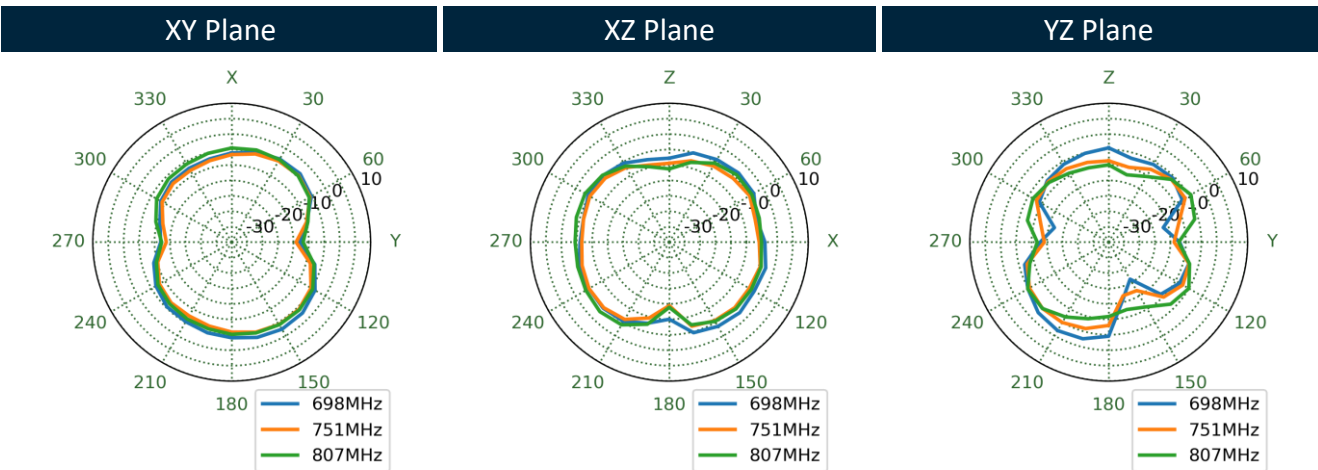
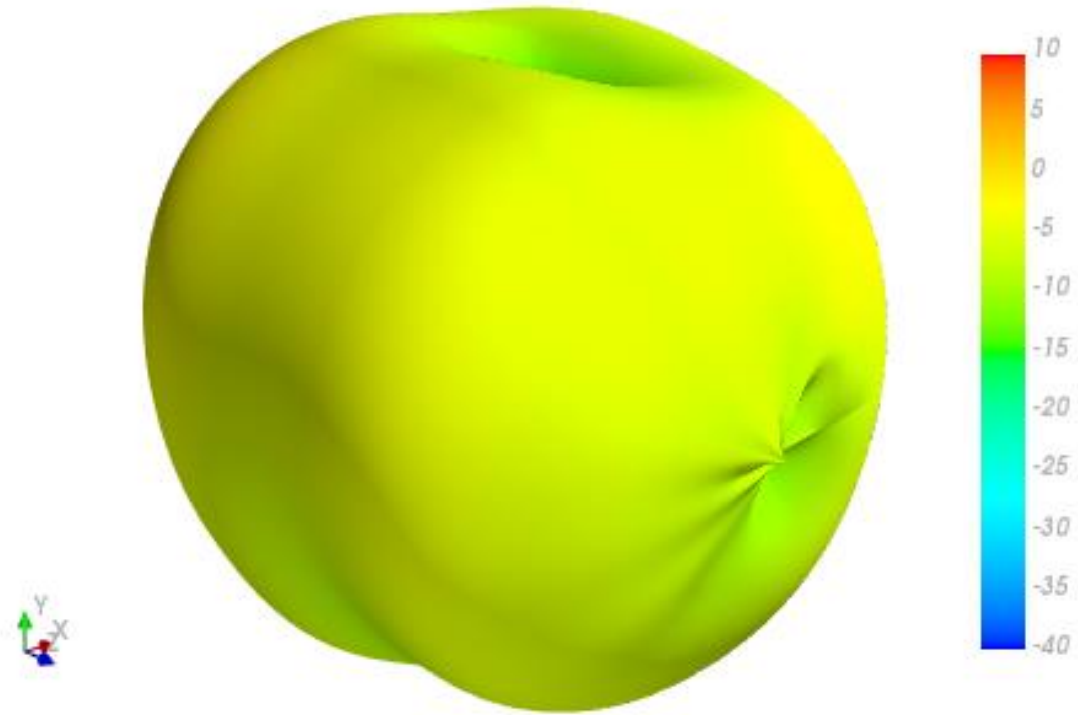

890MHz

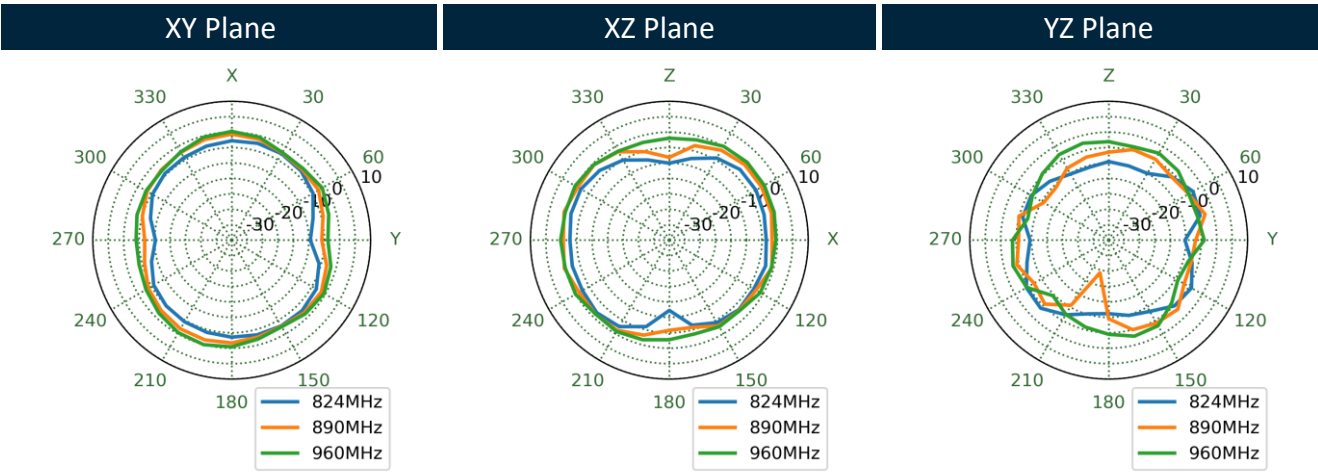
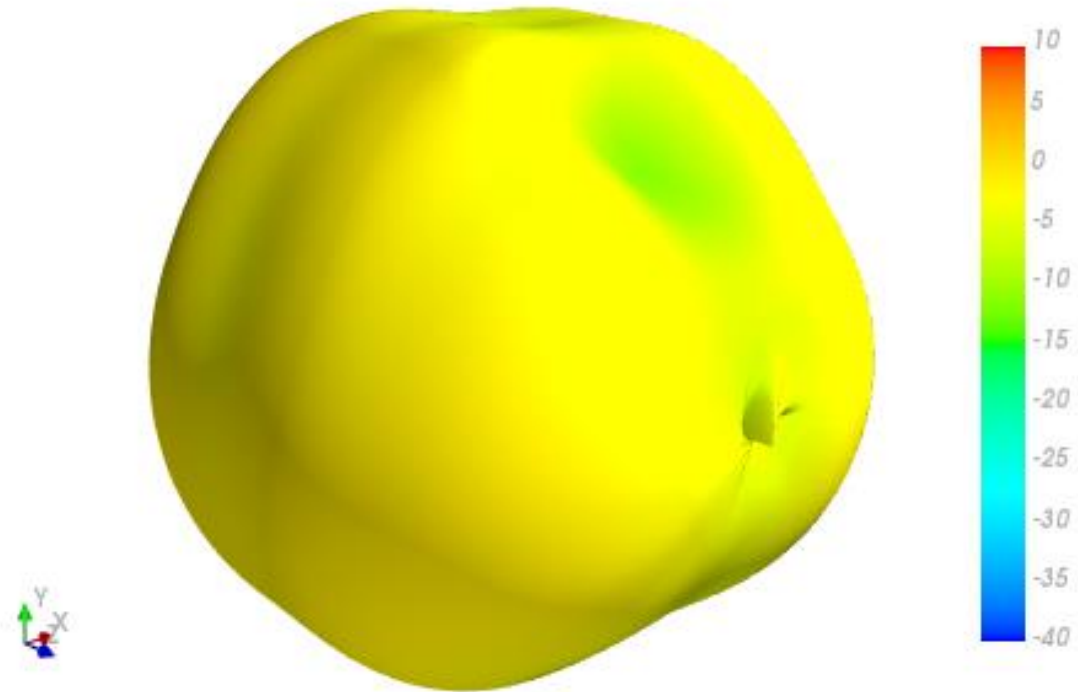

1470MHz

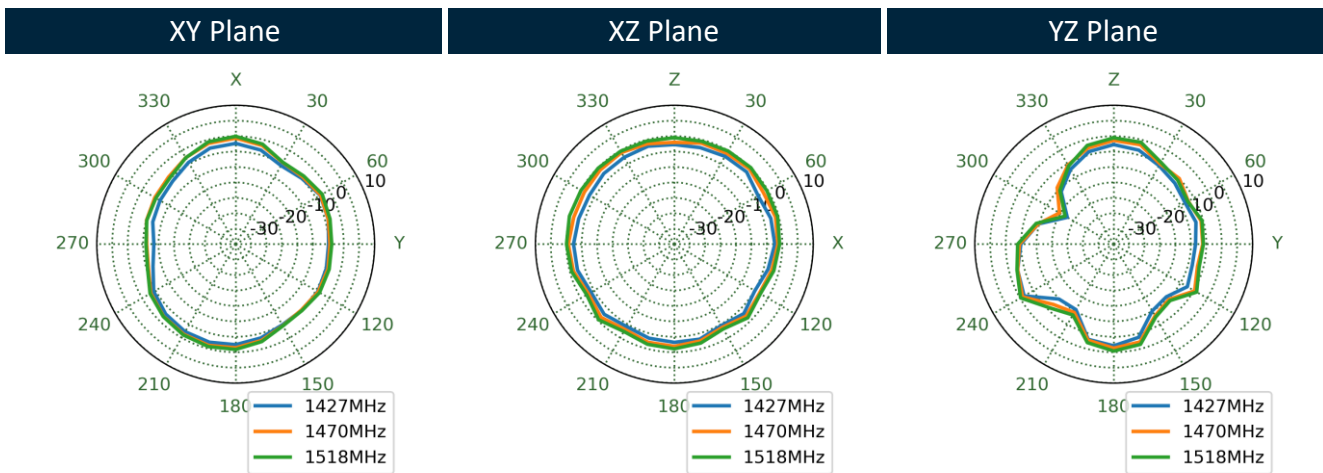
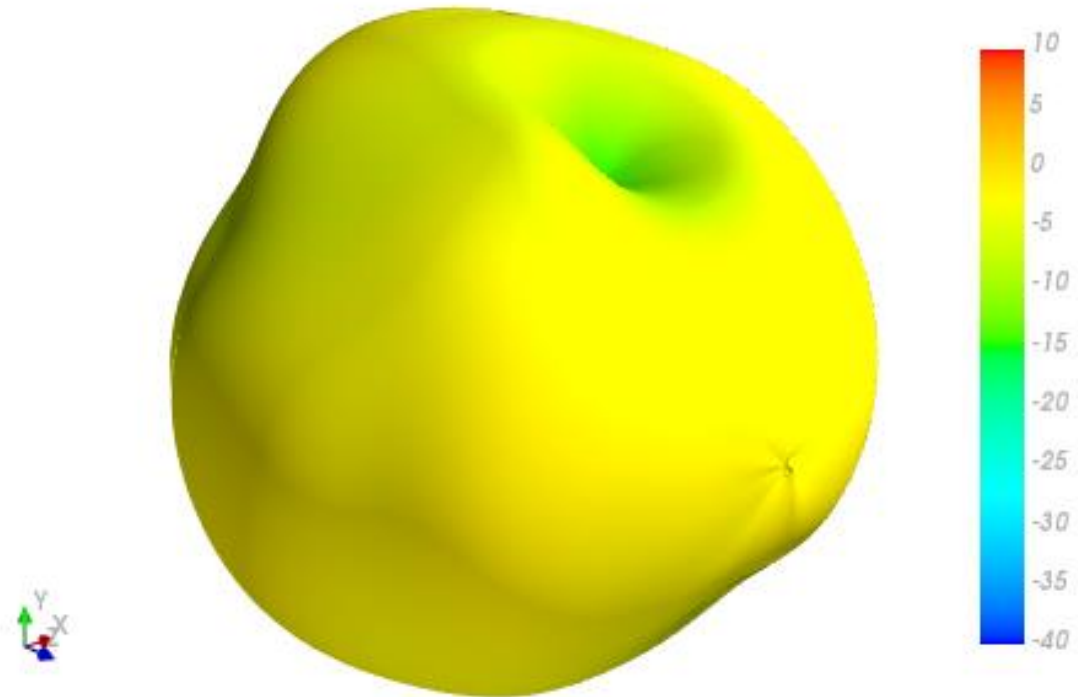



1805MHz

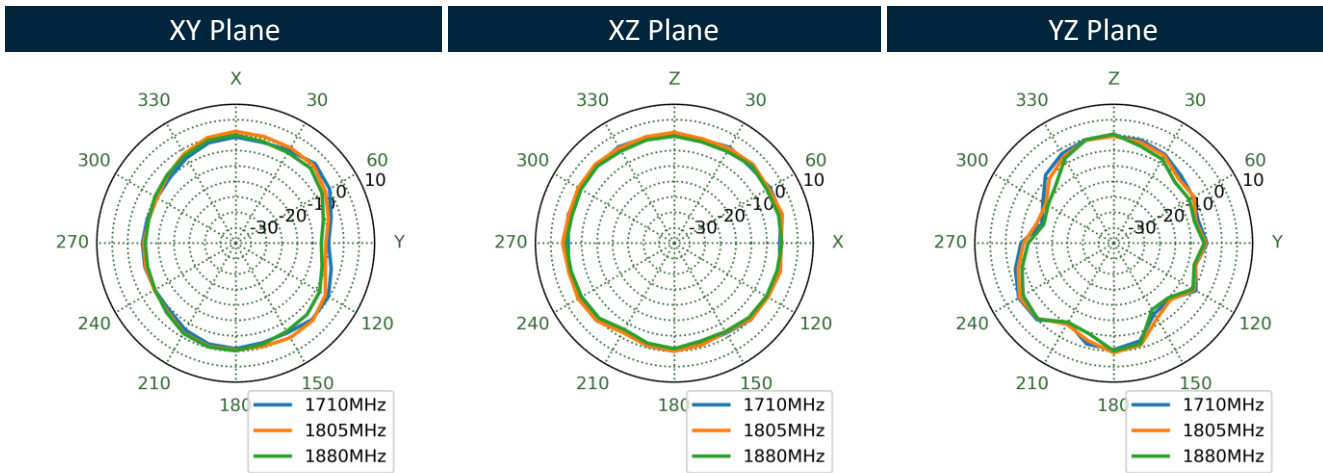
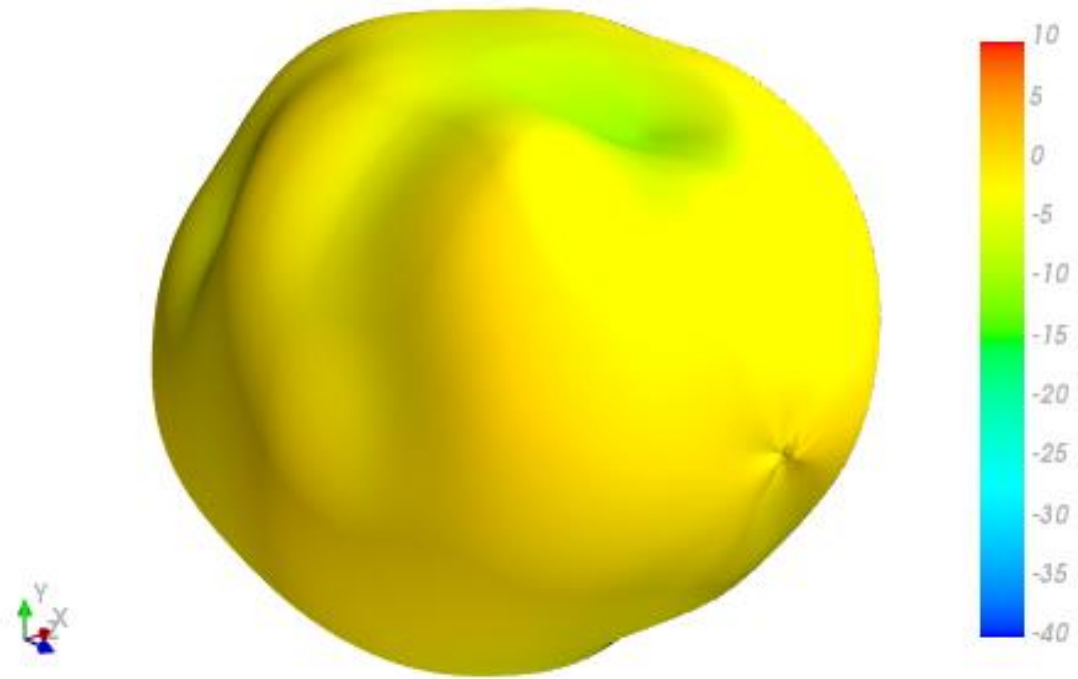

1920MHz

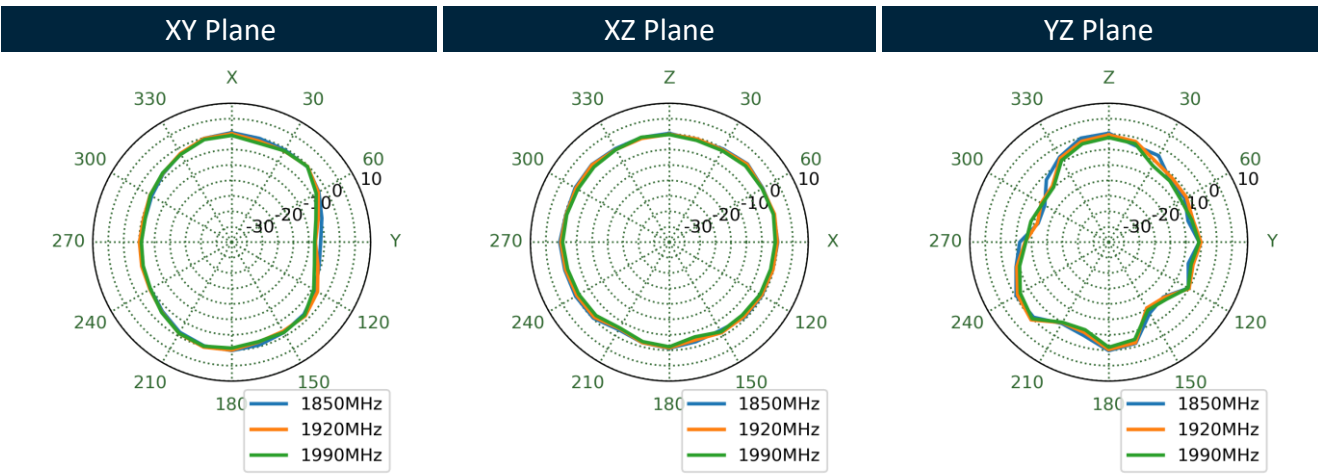
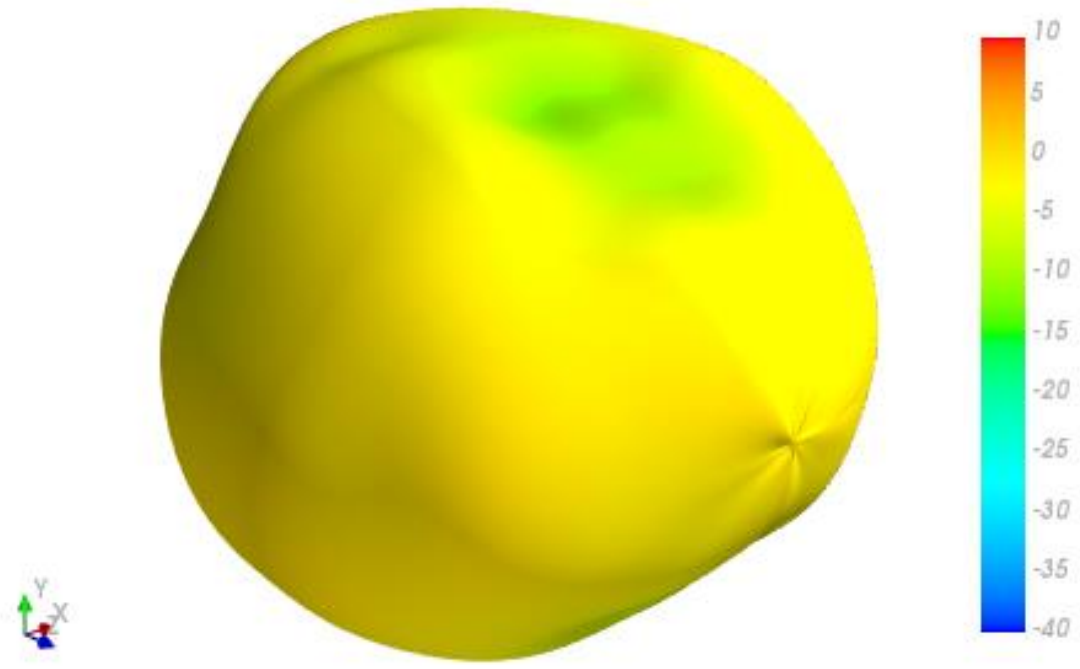

1990MHz

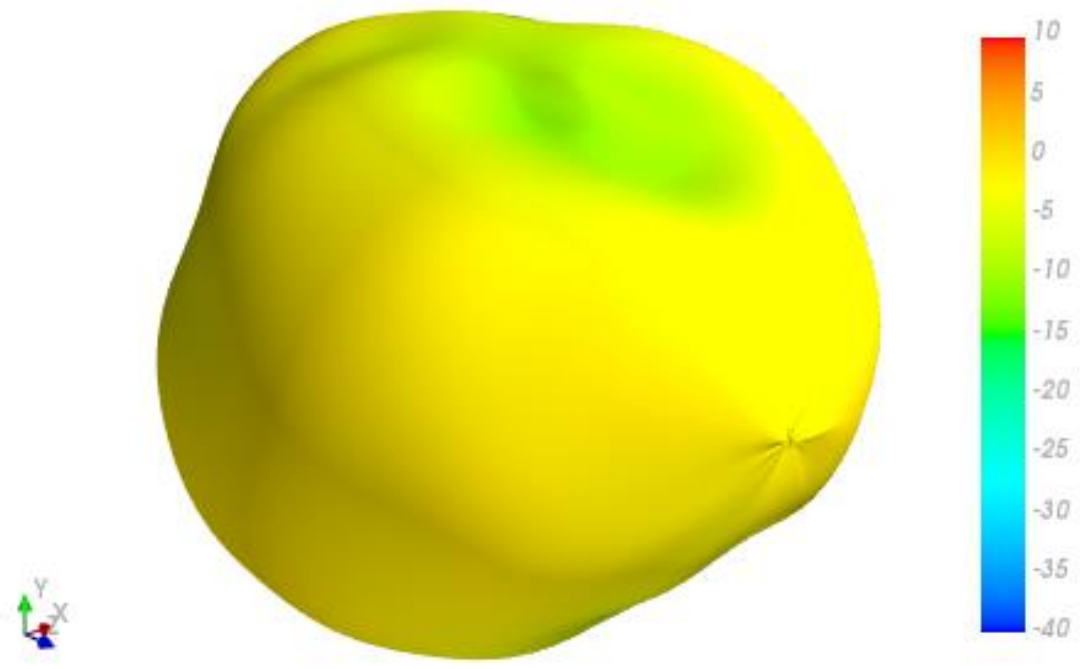

XY Plane      XZ Plane      YZ Plane

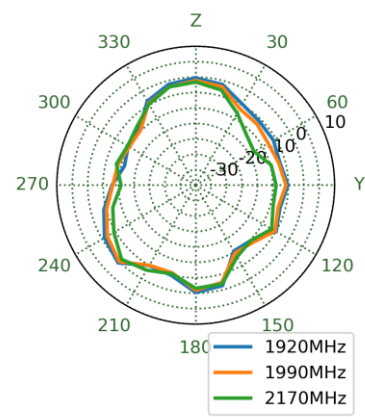
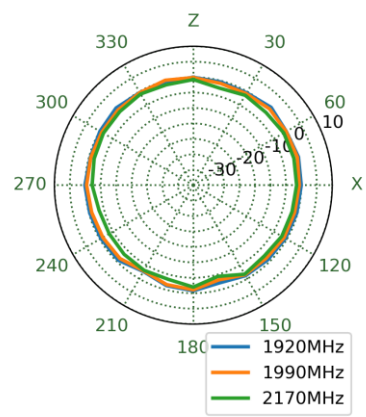
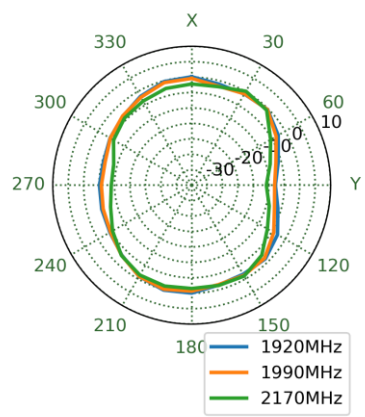

2595MHz

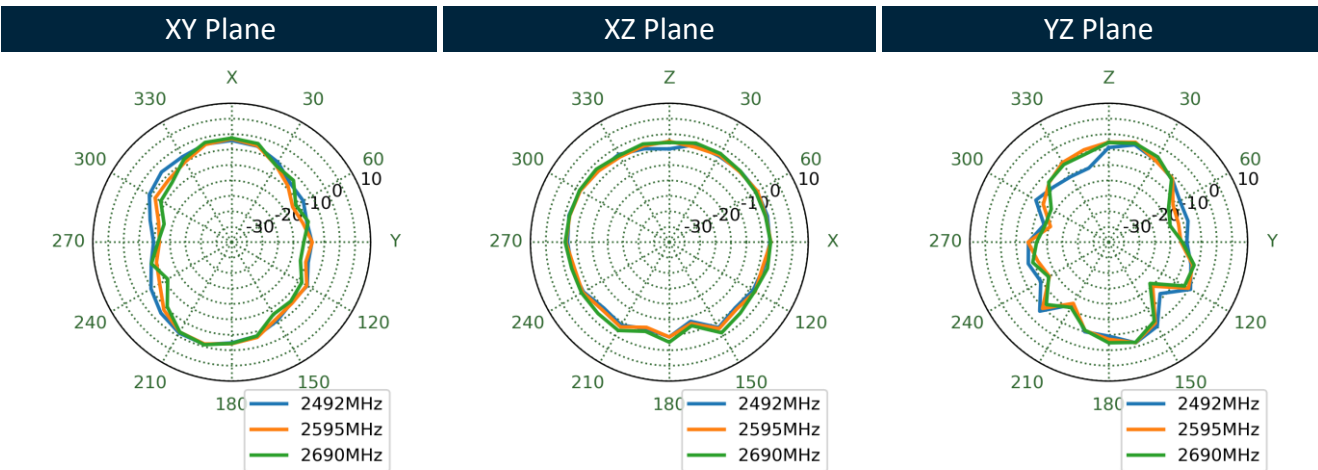
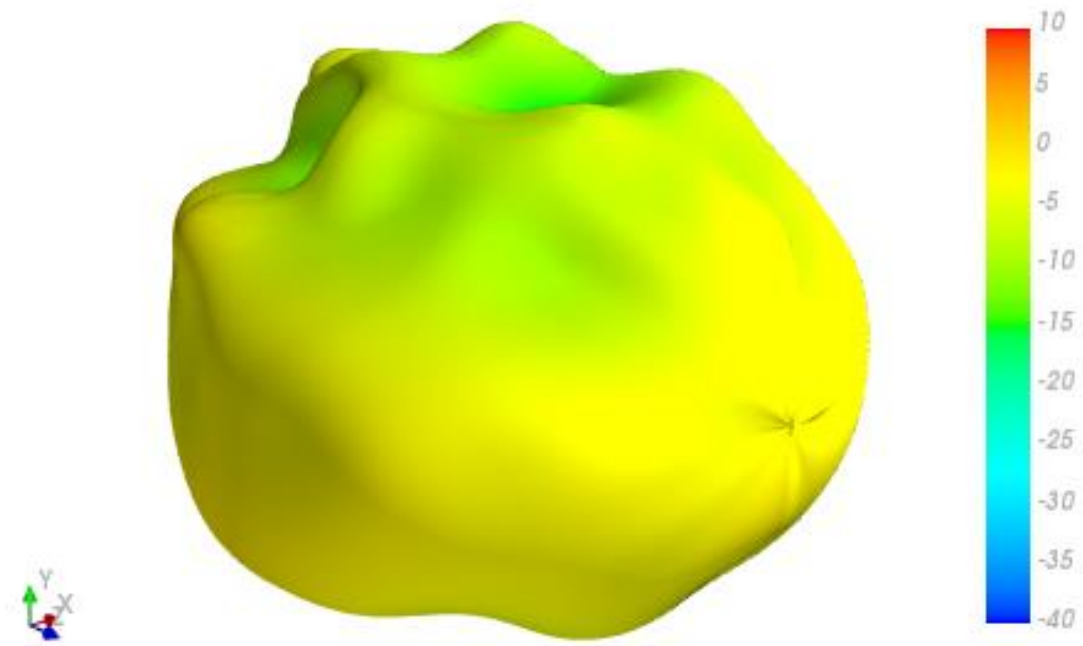

3550MHz

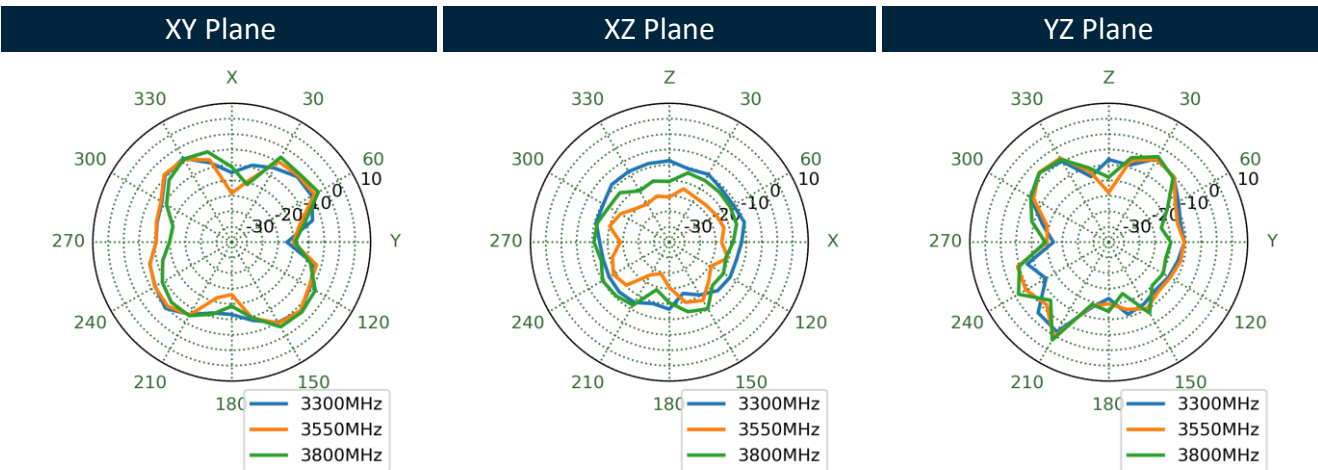
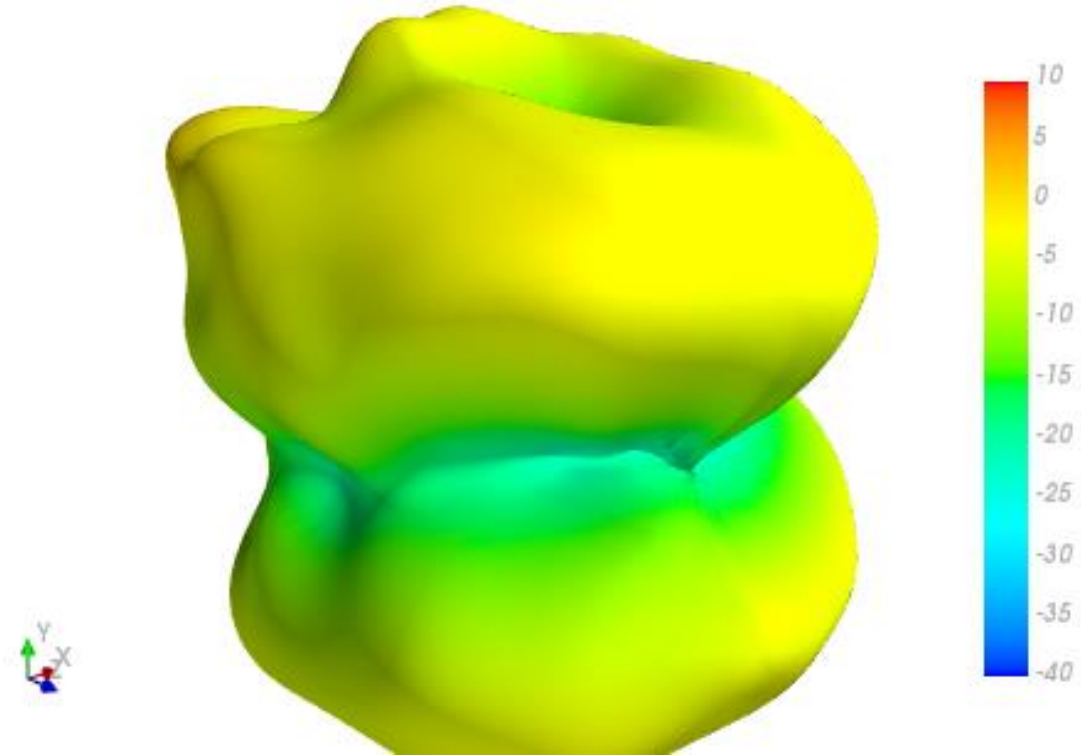

5530MHz

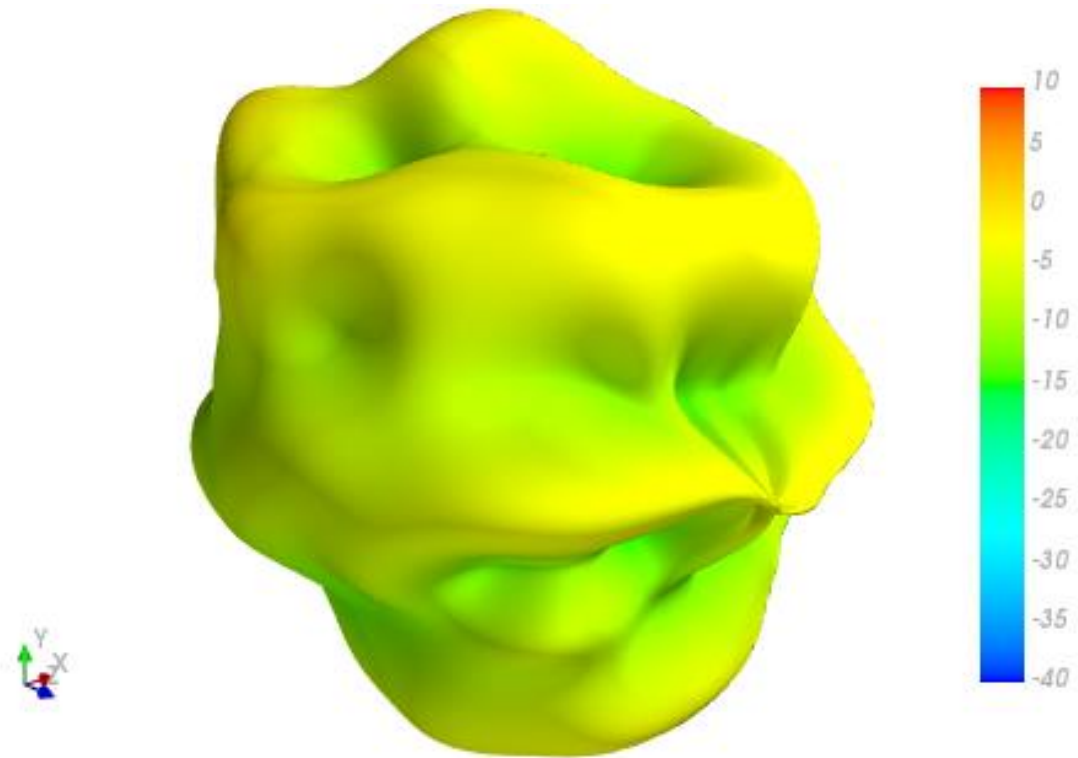

XY Plane

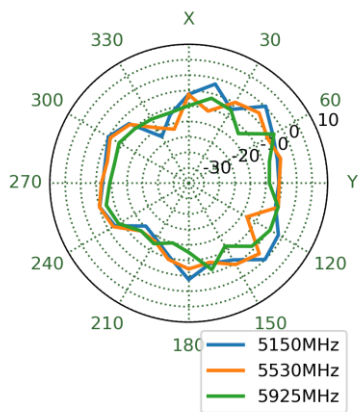

XZ Plane

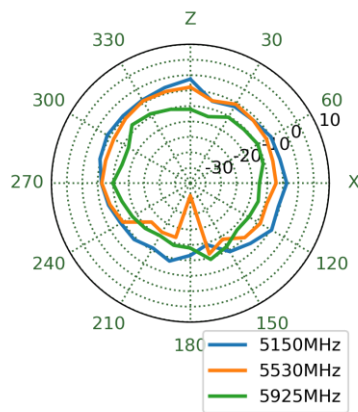

YZ Plane

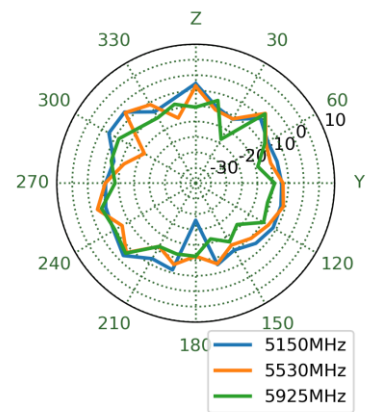

4.9 Test Setup

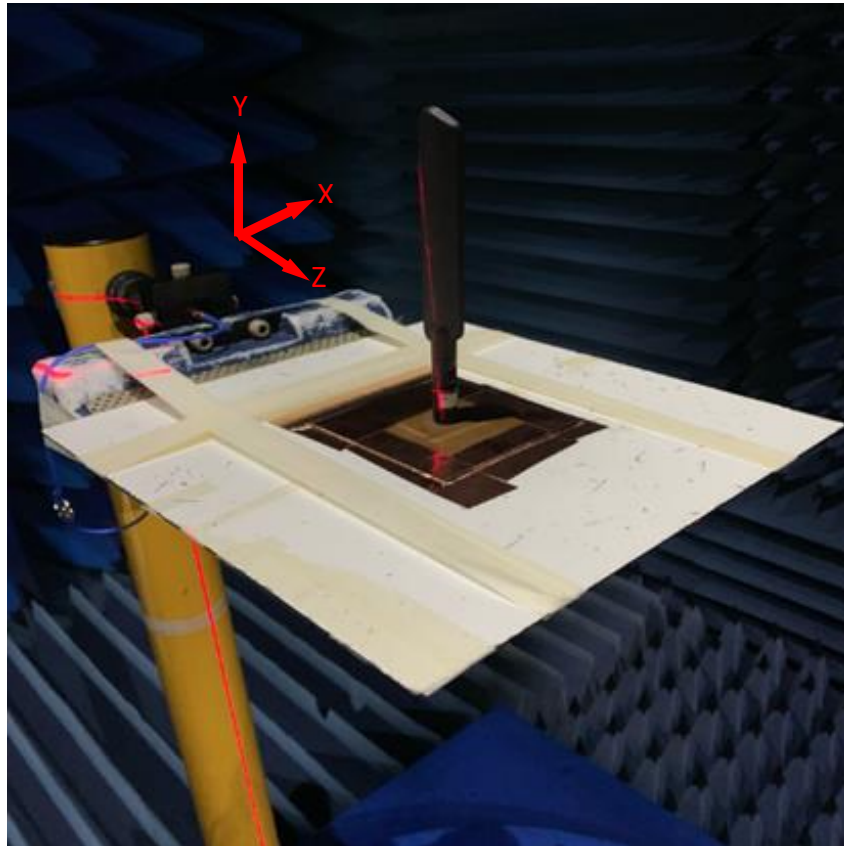

Straight 30x30cm Ground Plane Centre



## 4.10 Straight 30x30cm Ground Plane Centre 2D & 3D Radiation Patterns

652MHz

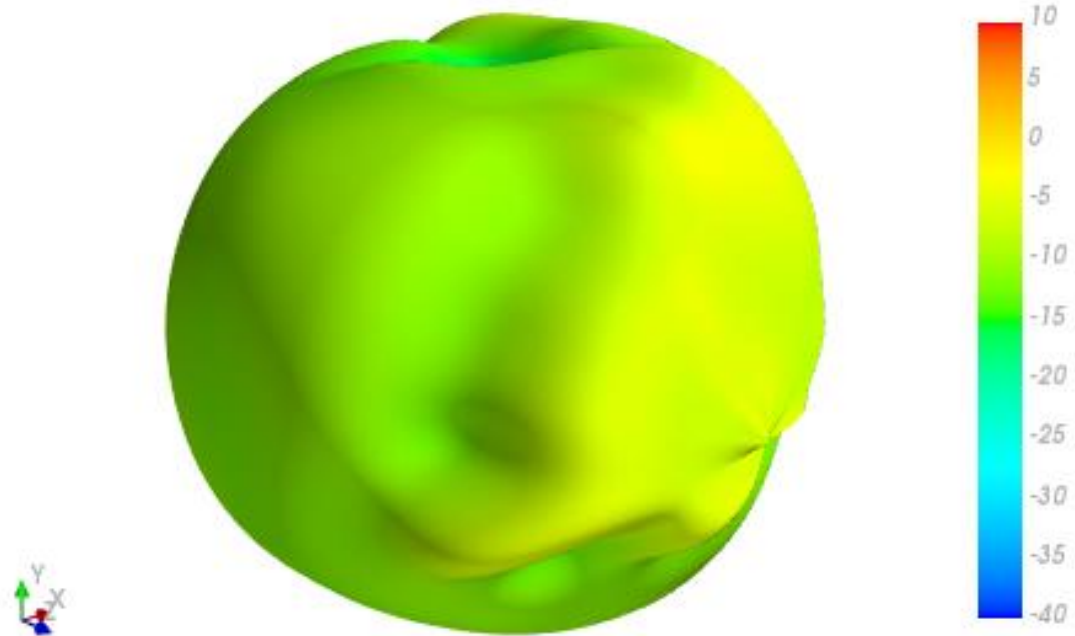

XY Plane

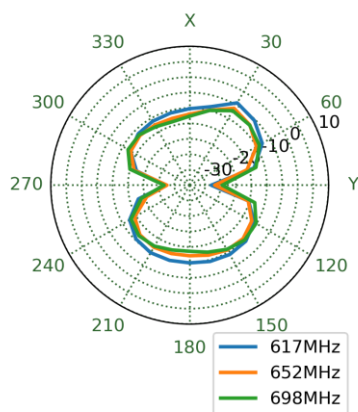

XZ Plane

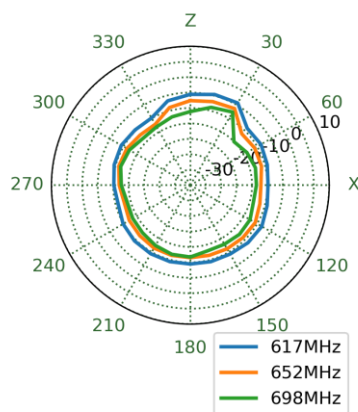

YZ Plane

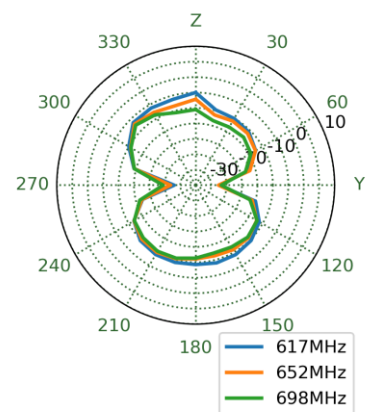

751MHz

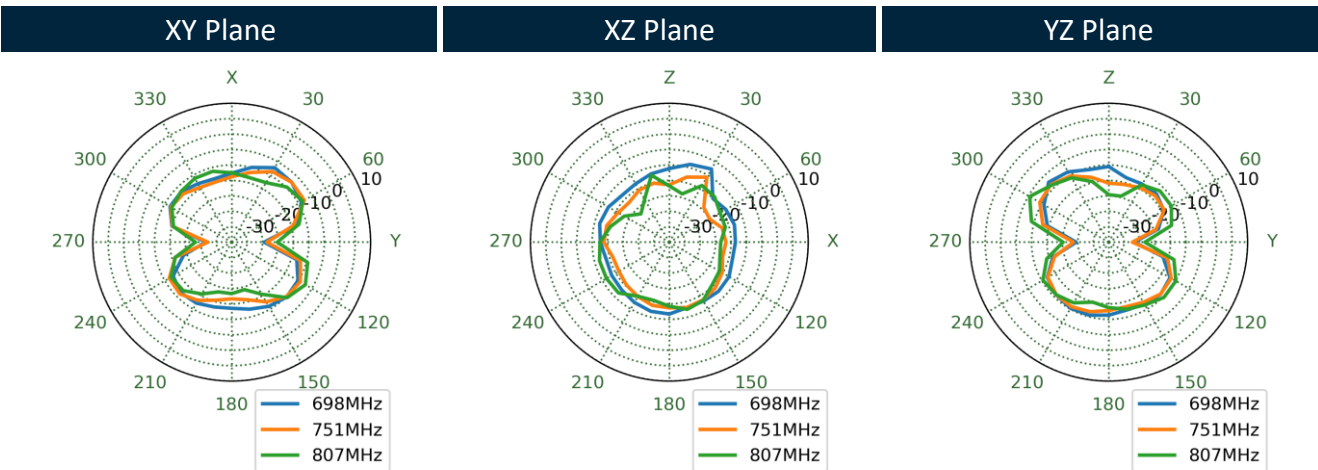
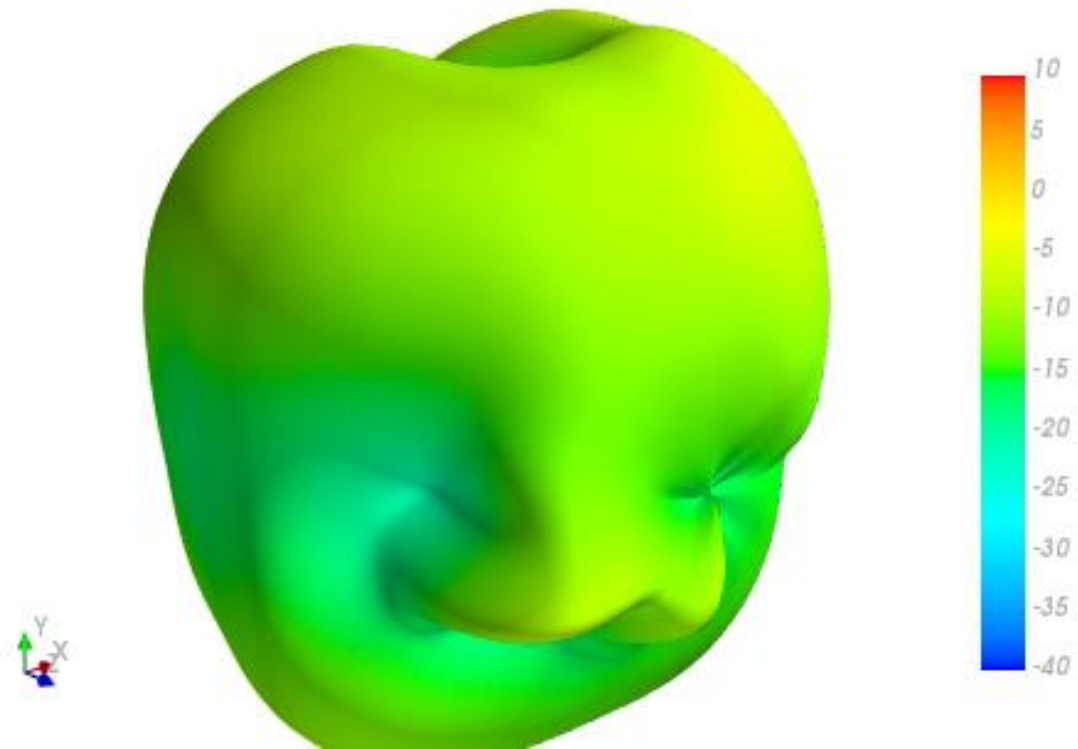

890MHz

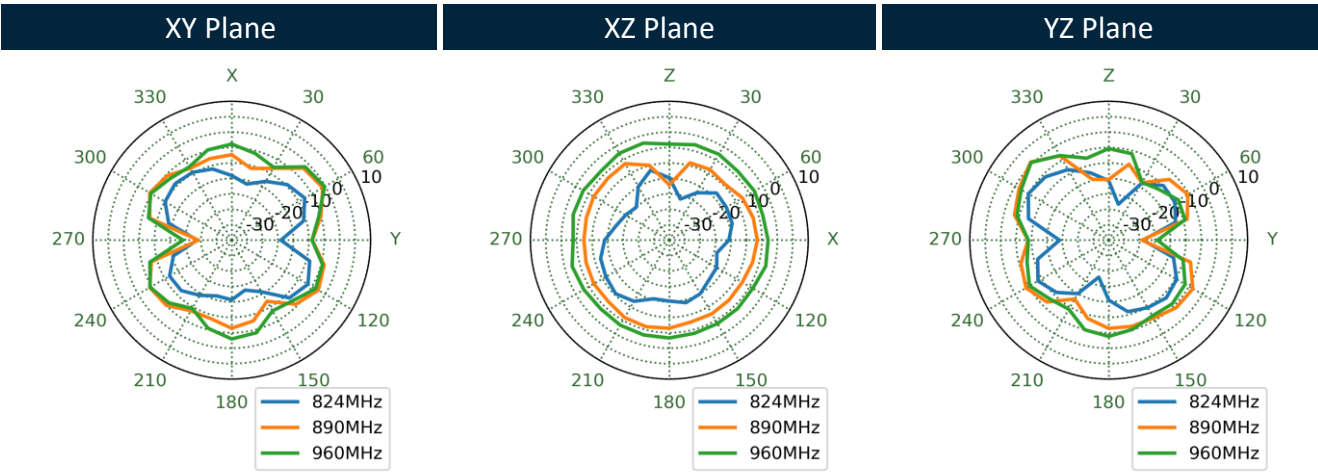
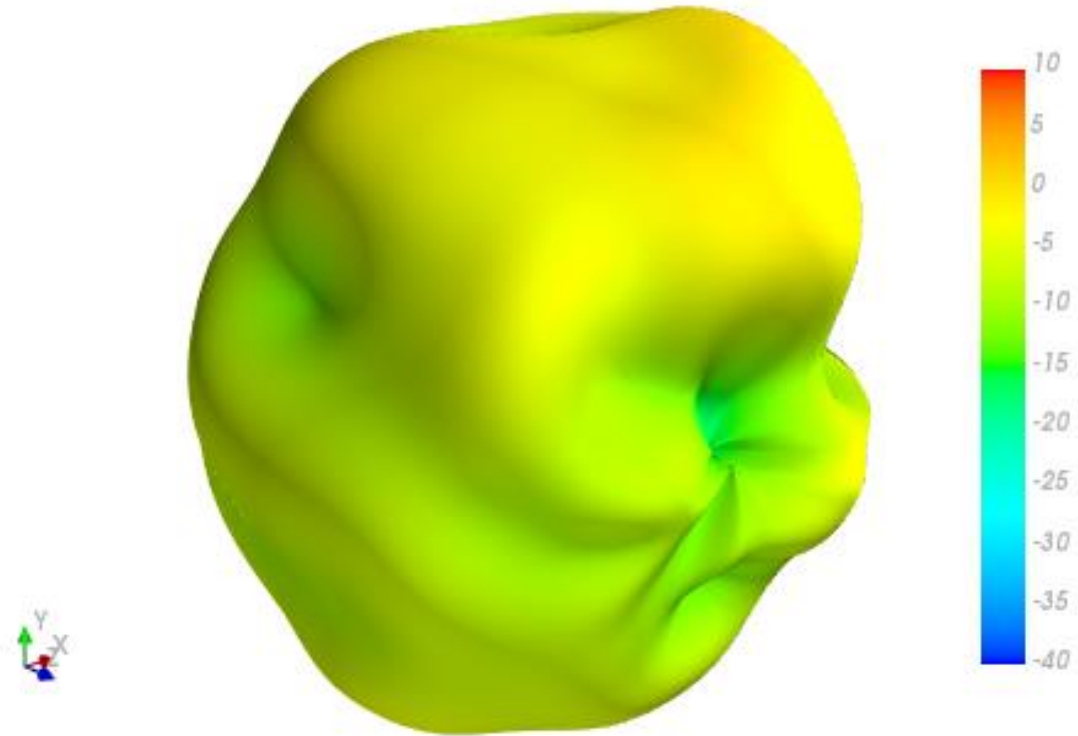

1470MHz

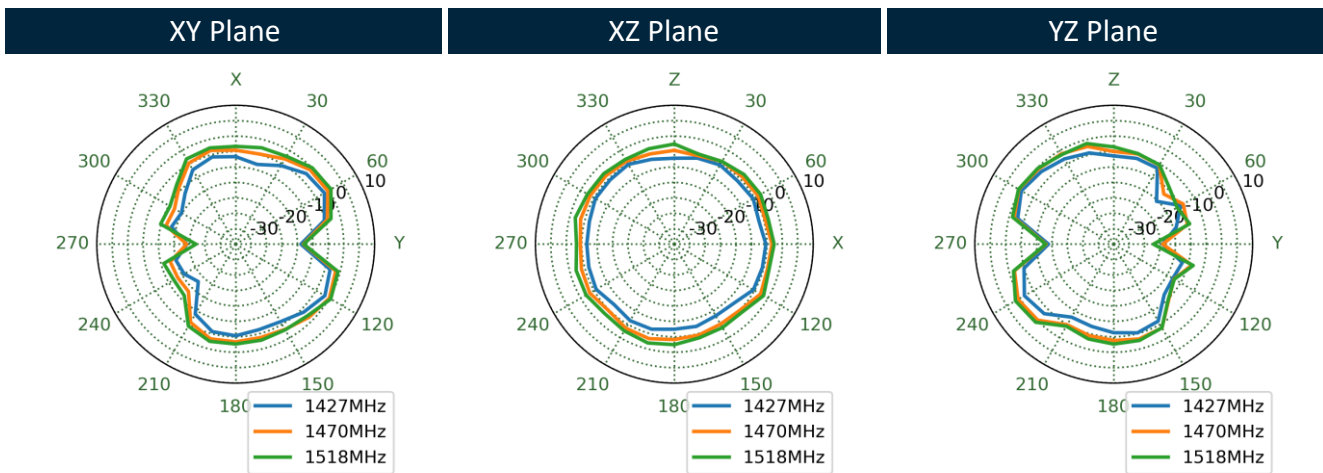
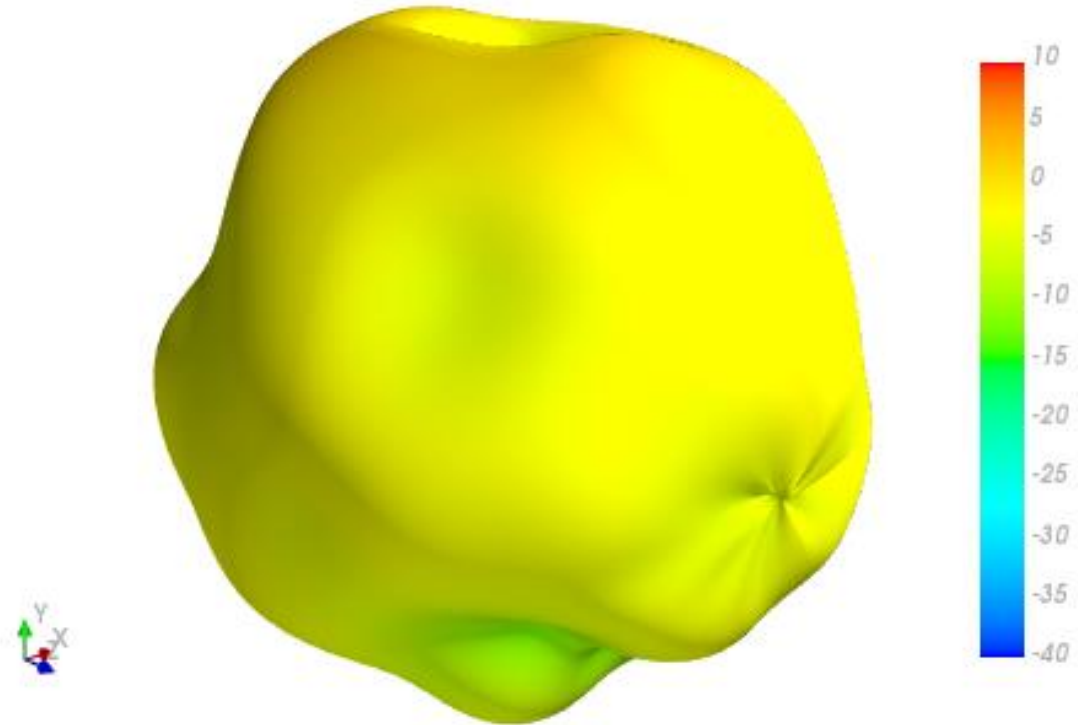

1805MHz

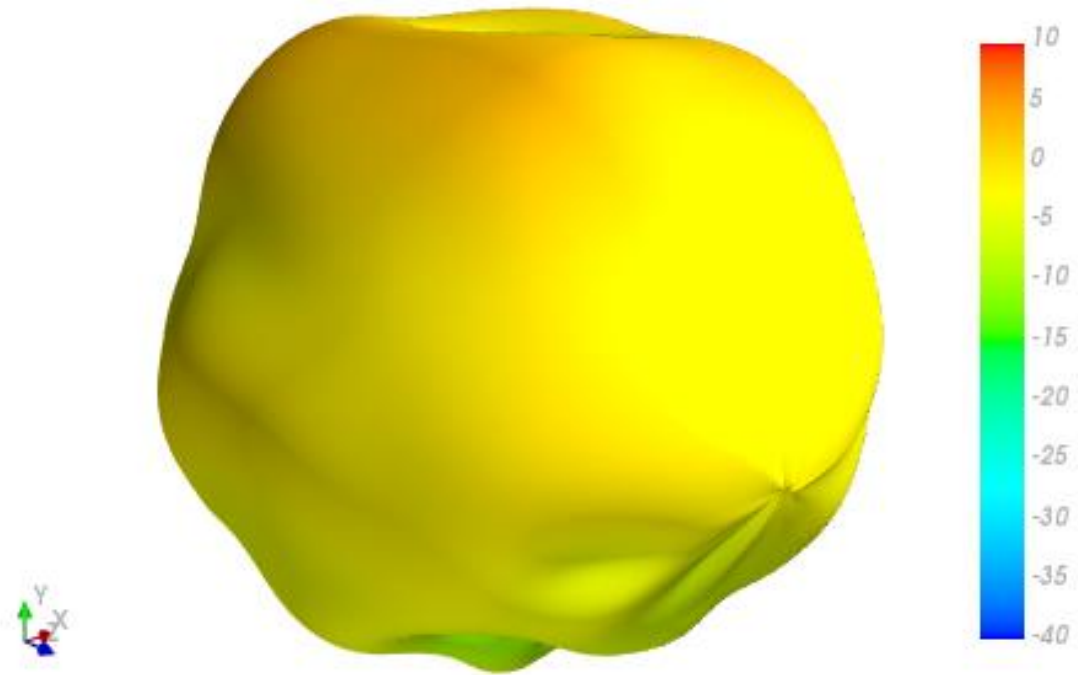

XY Plane

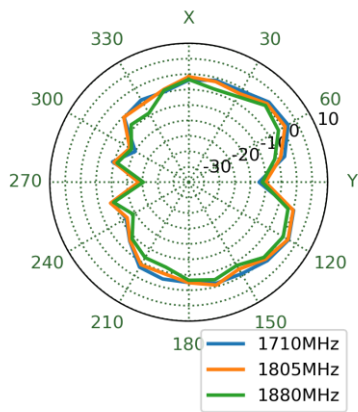

XZ Plane

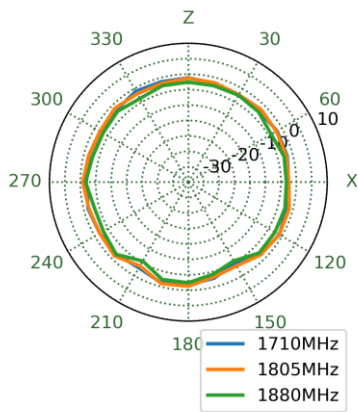

YZ Plane

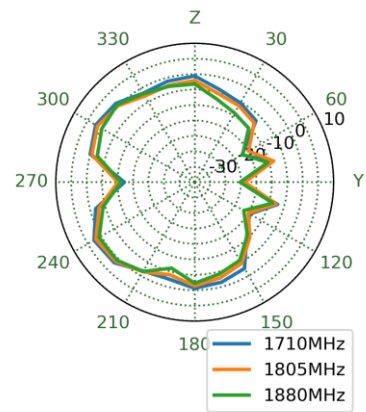

1920MHz

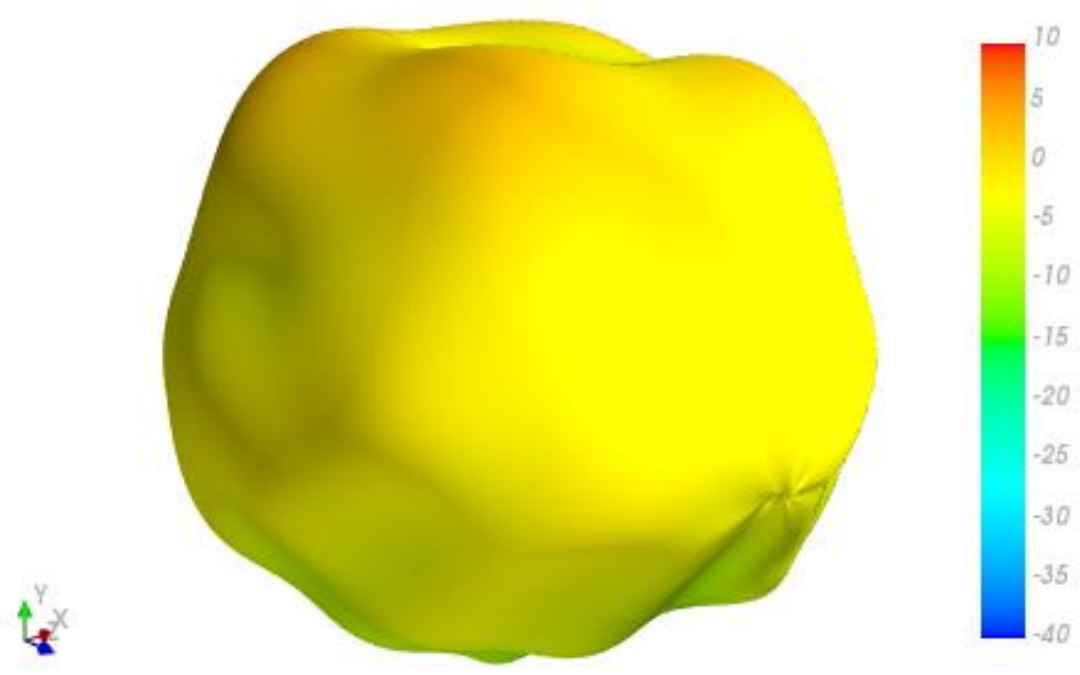

XY Plane      XZ Plane      YZ Plane

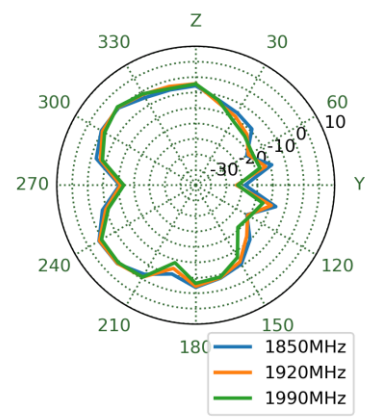
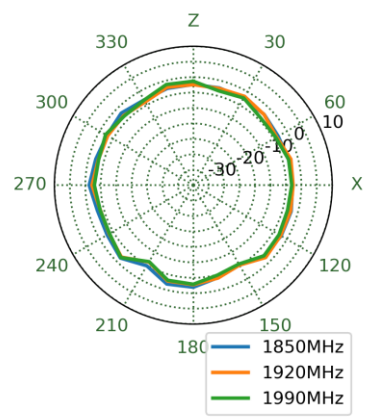
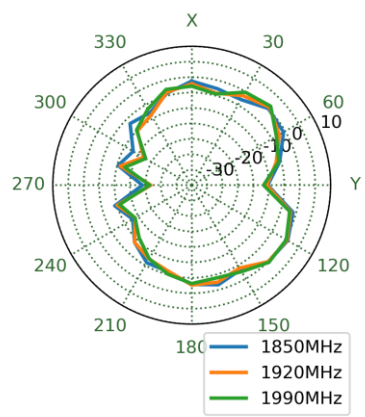

1990MHz

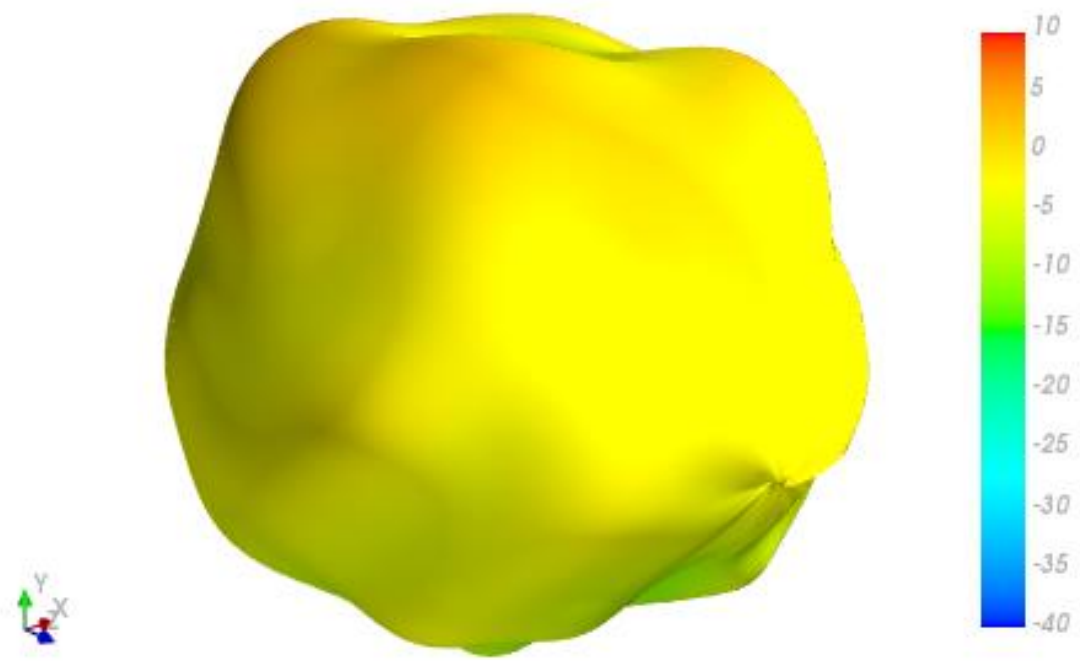

XY Plane      XZ Plane      YZ Plane

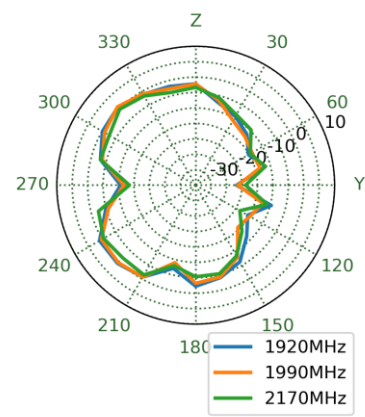
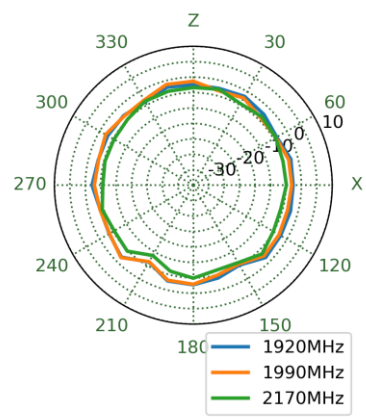
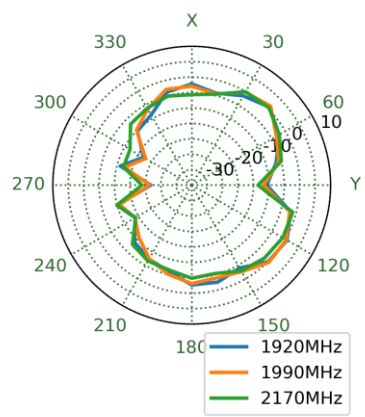



2595MHz

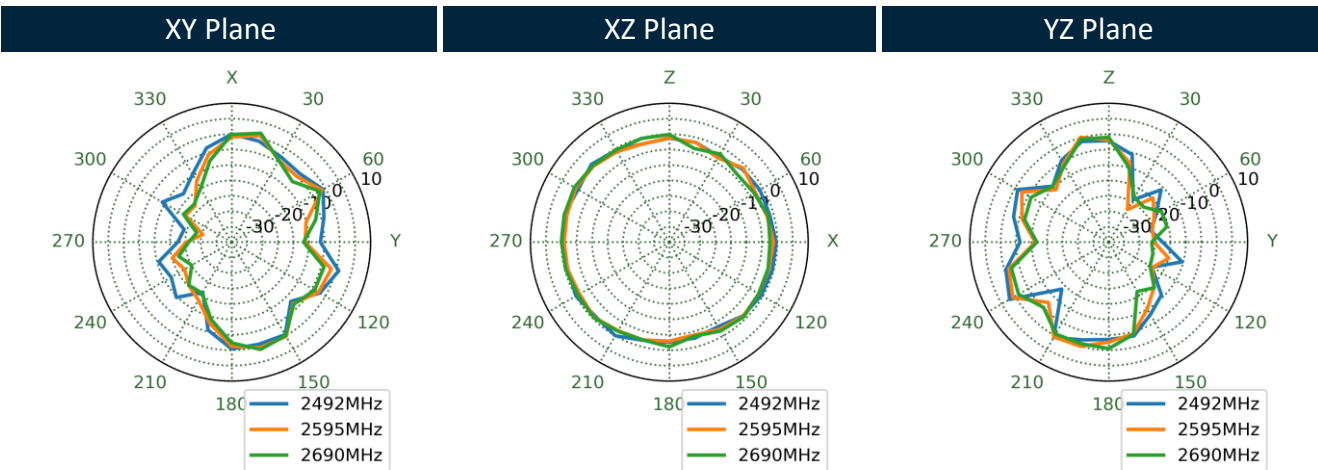
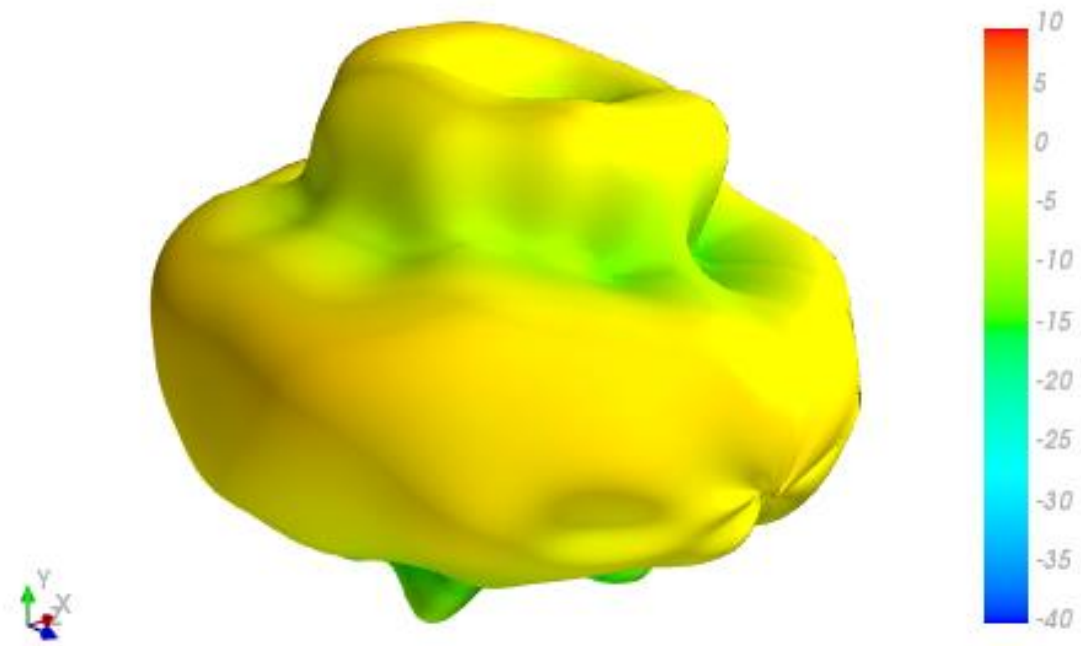

3550MHz

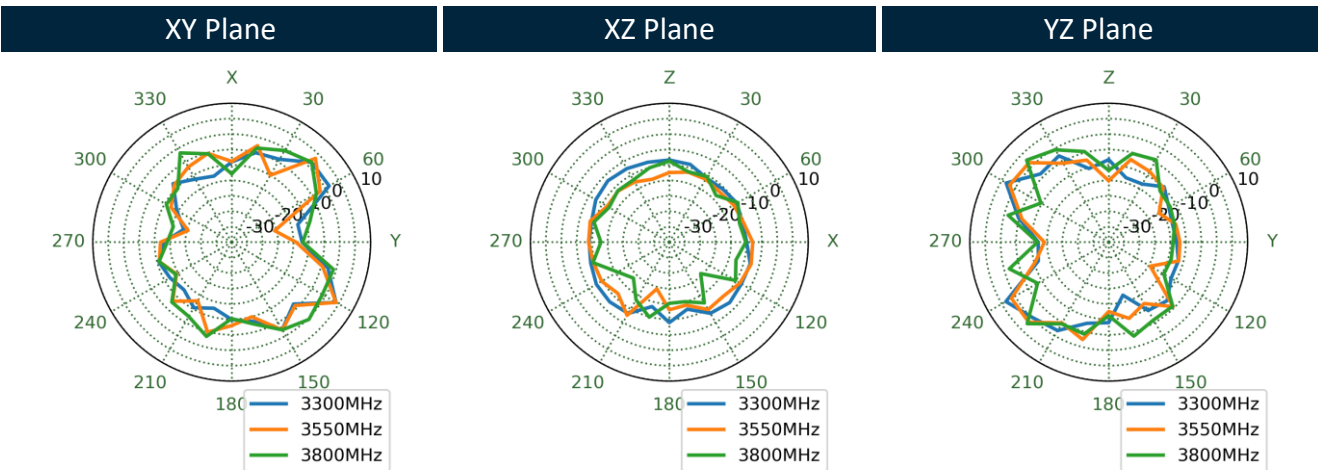
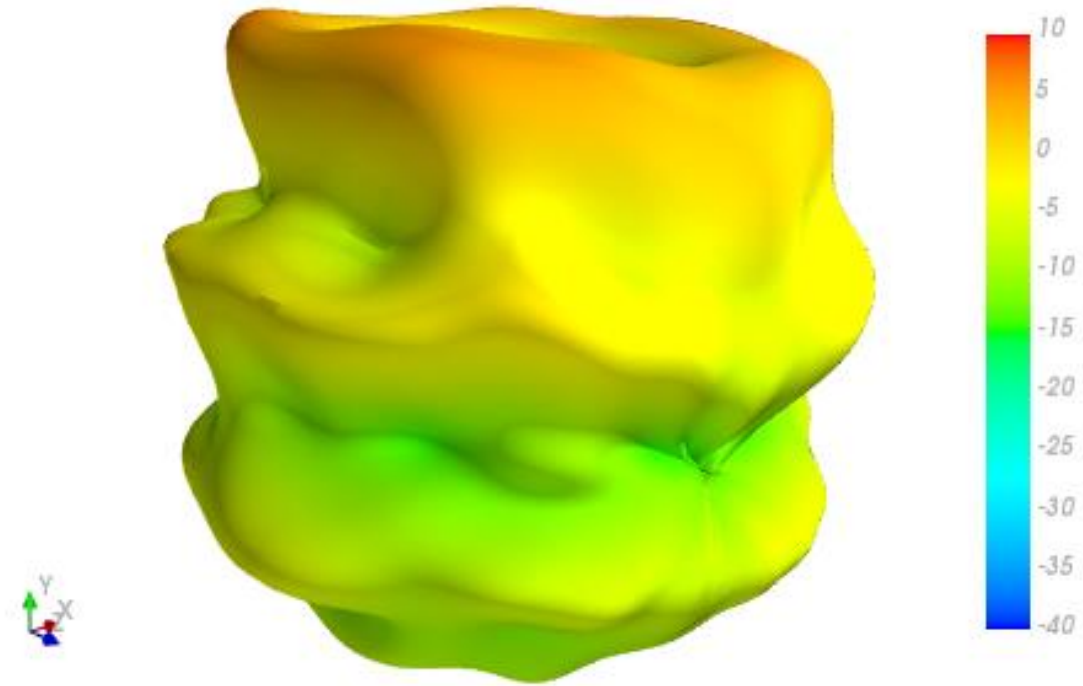

5530MHz

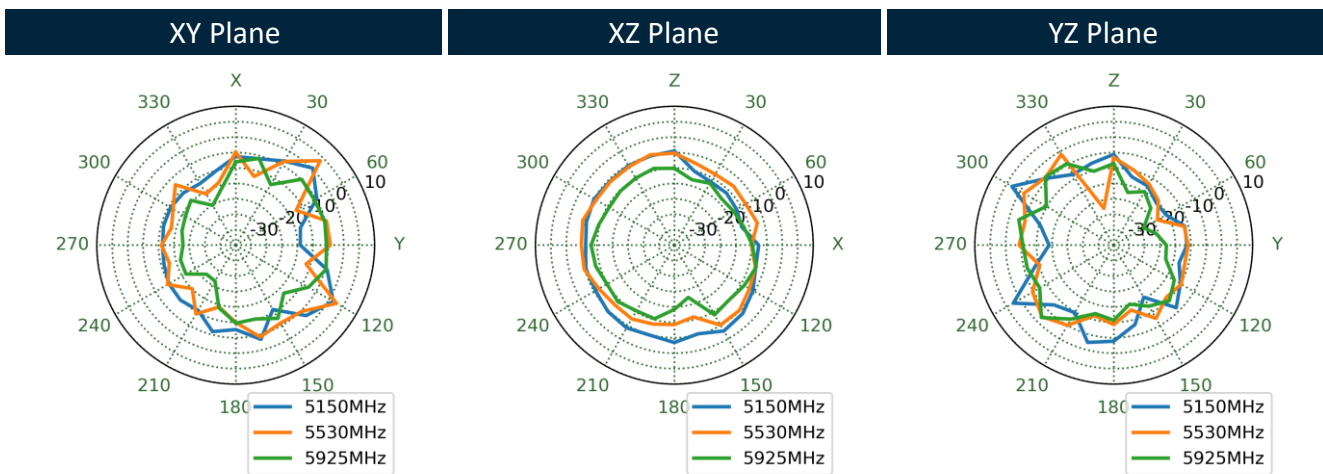
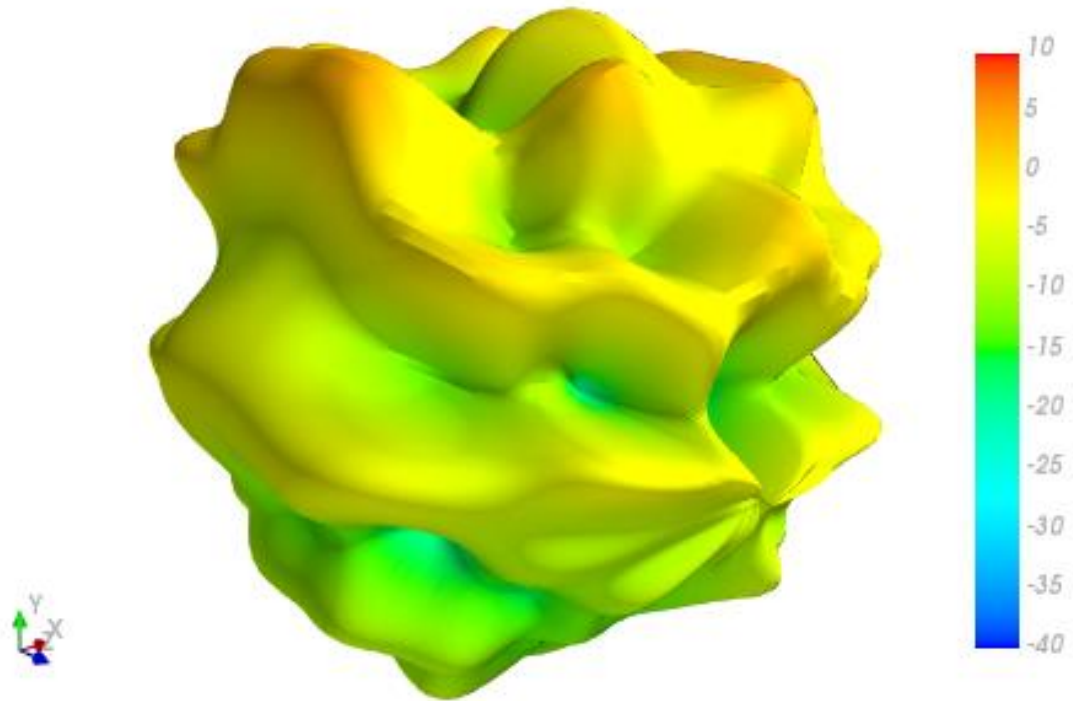

4.11 Test Setup

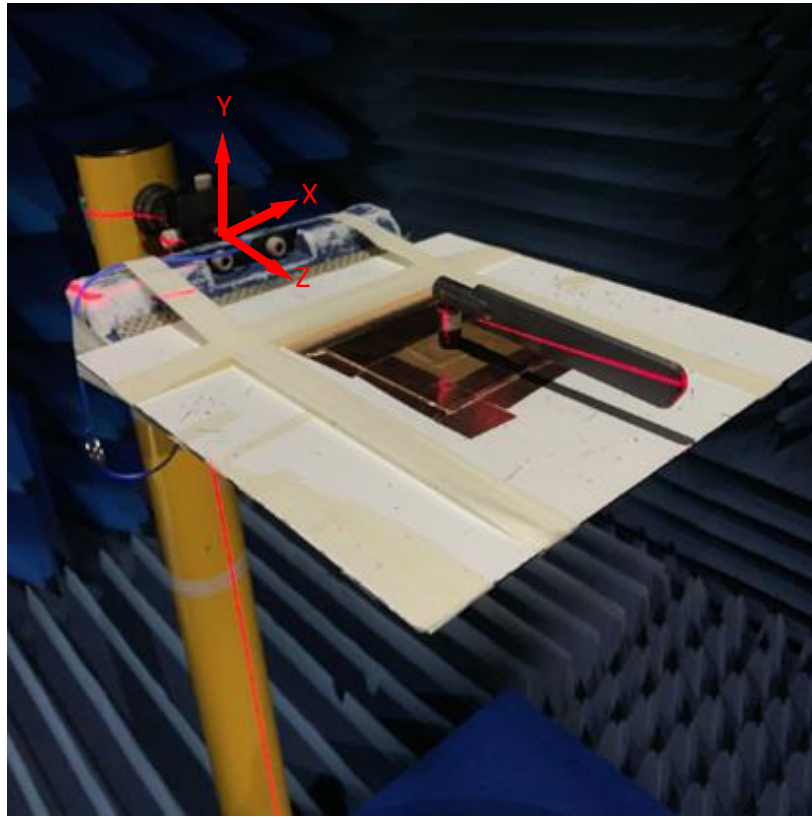

Bent 30x30cm Ground Plane Centre

## 4.12 Bent 30x30cm Ground Plane Centre 2D & 3D Radiation Patterns

652MHz

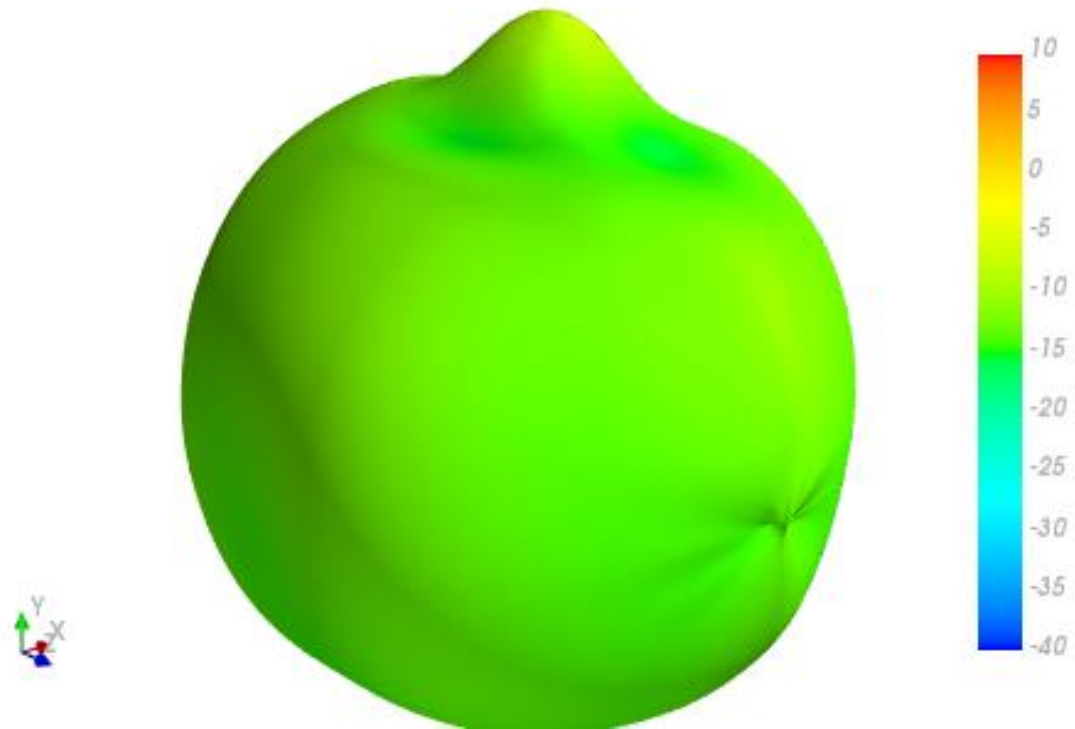

XY Plane

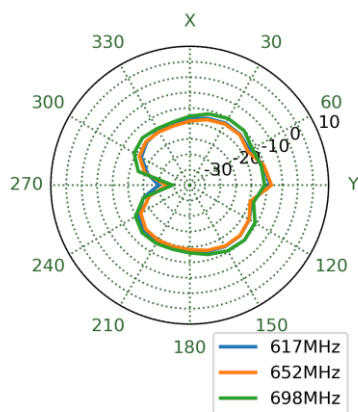

XZ Plane

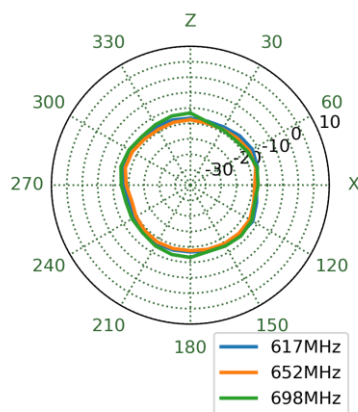

YZ Plane

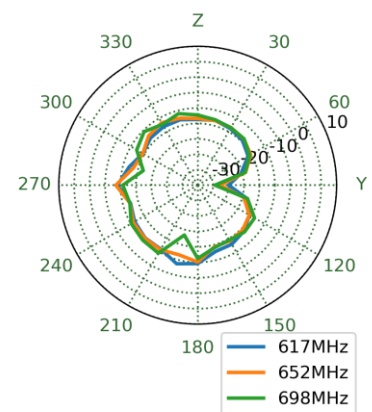

751MHz

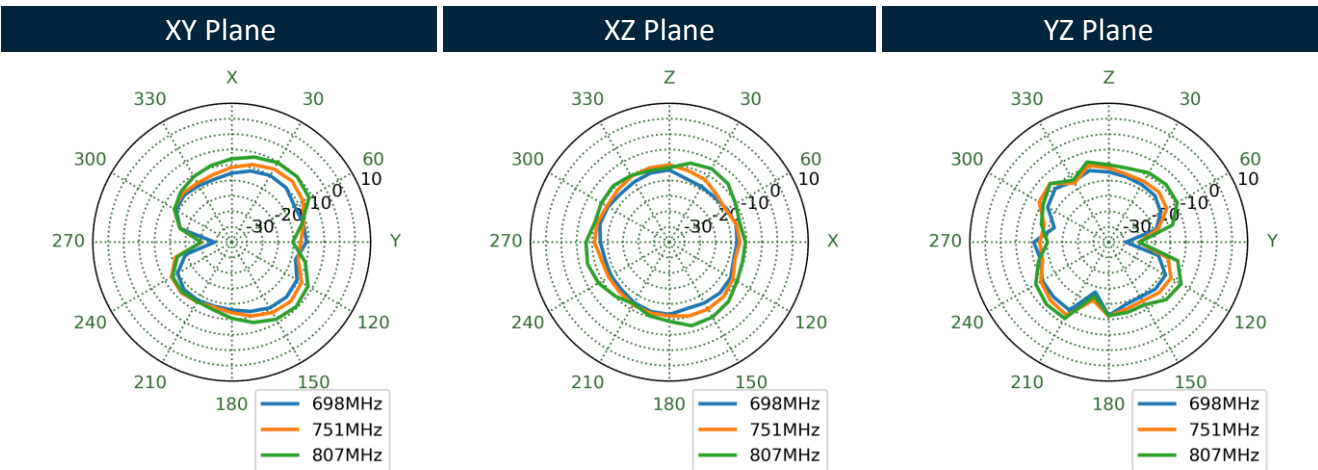
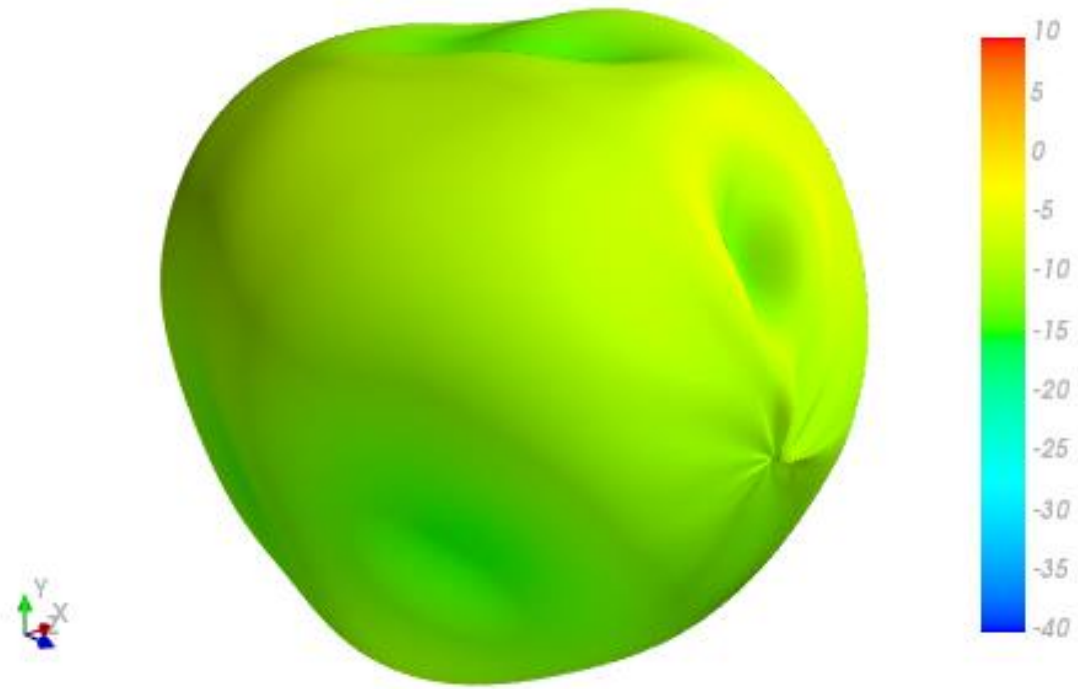

890MHz

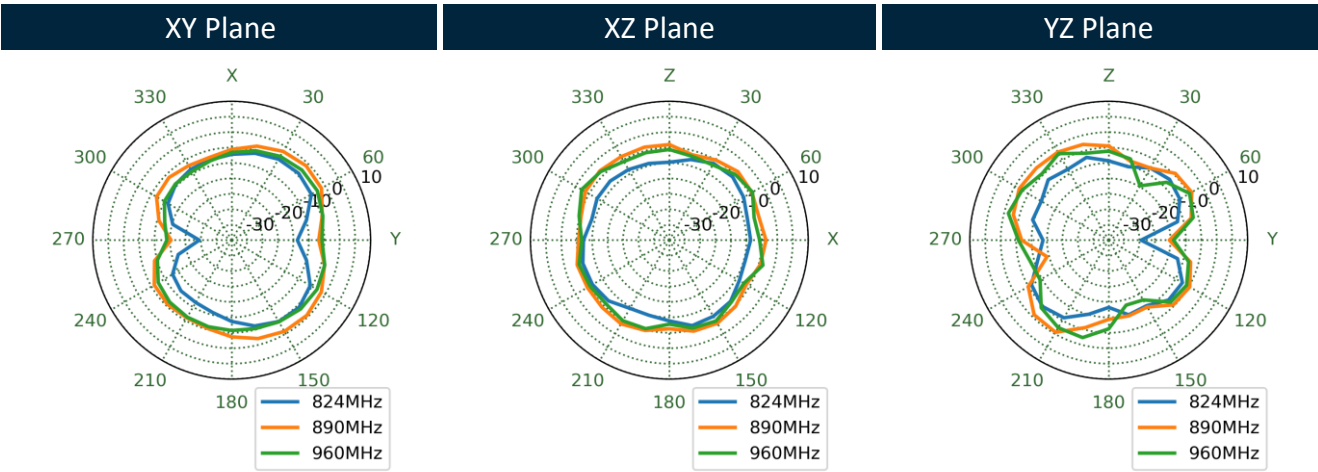
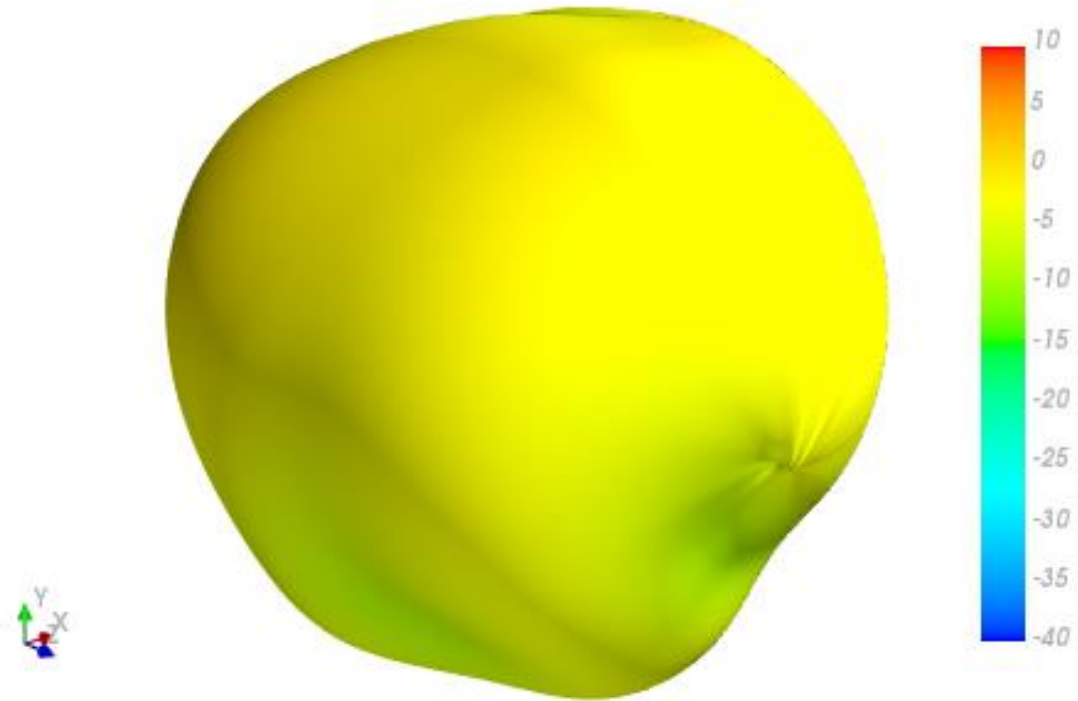



1470MHz

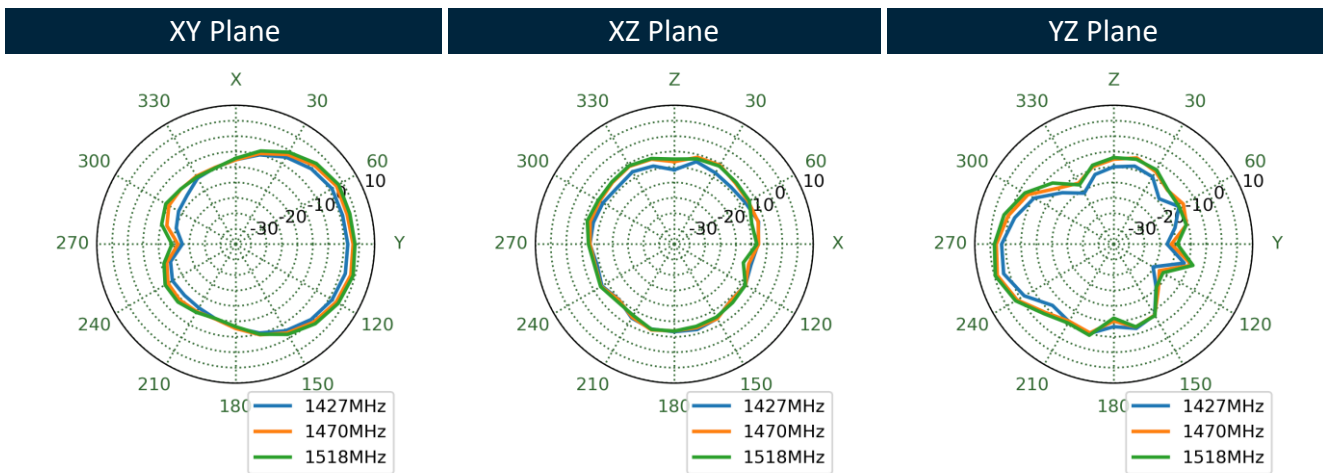
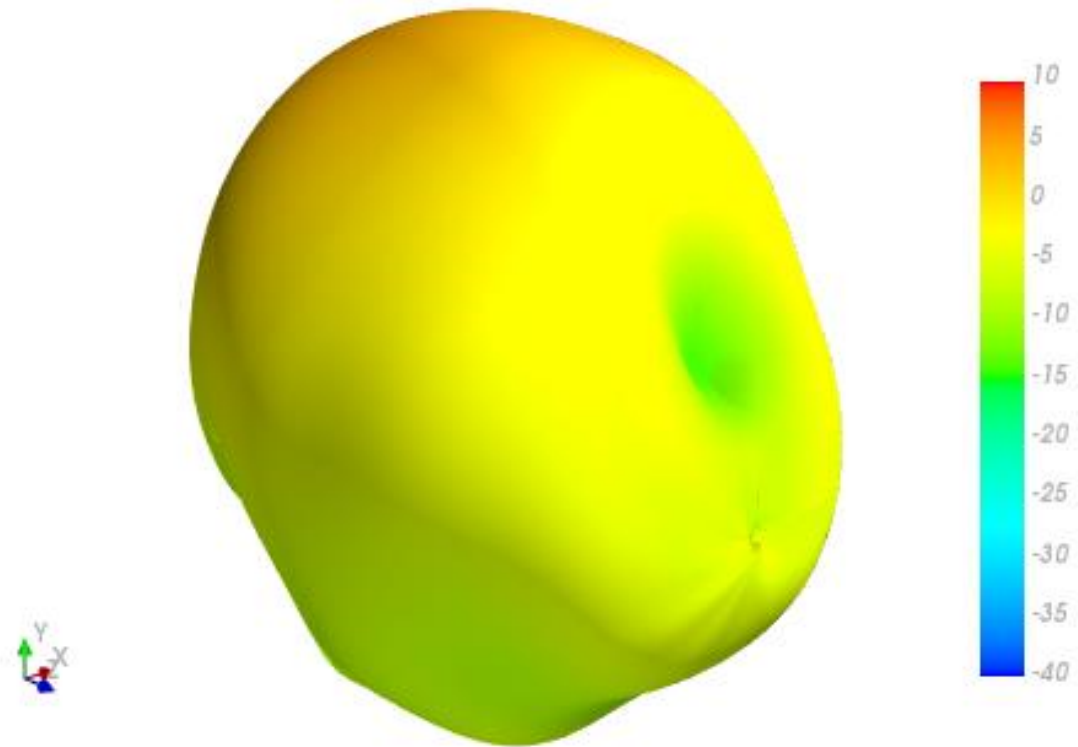

1805MHz

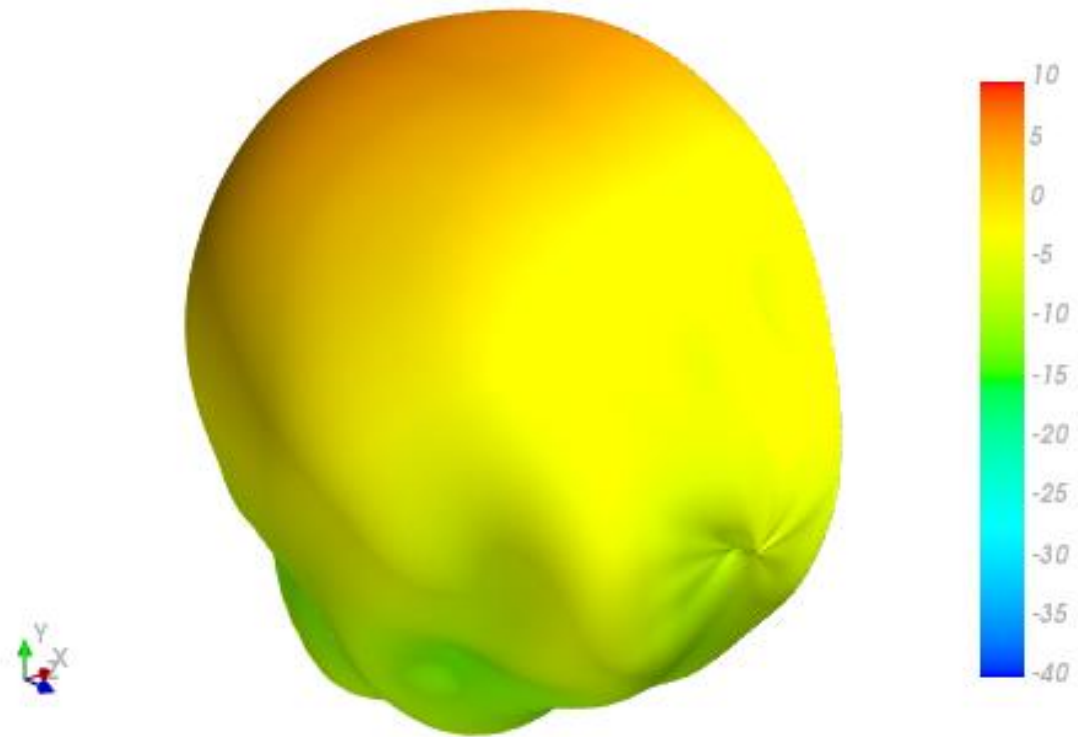

XY Plane

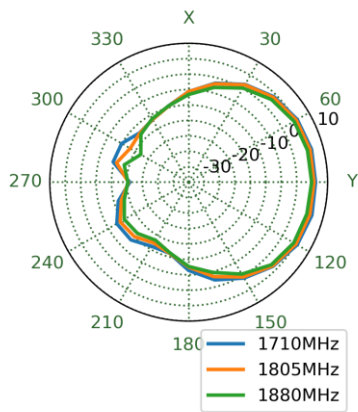

XZ Plane

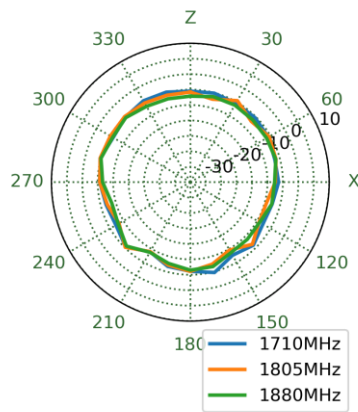

YZ Plane

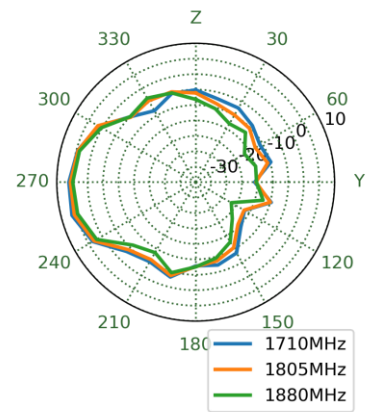

1920MHz

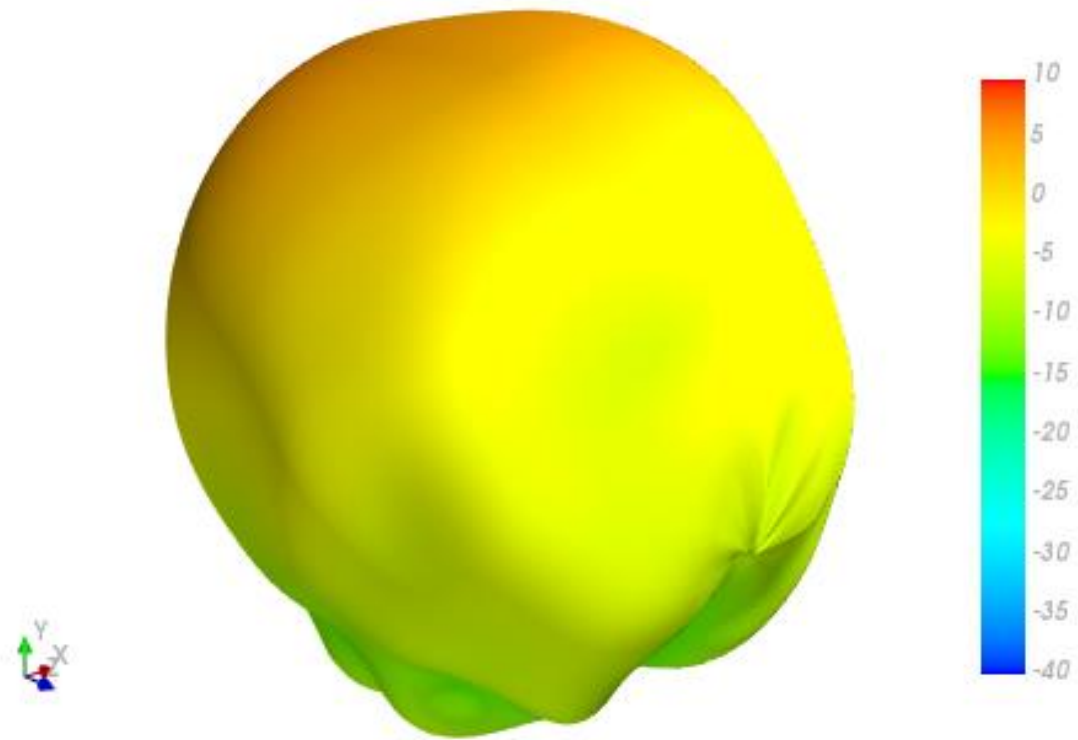

XY Plane      XZ Plane      YZ Plane

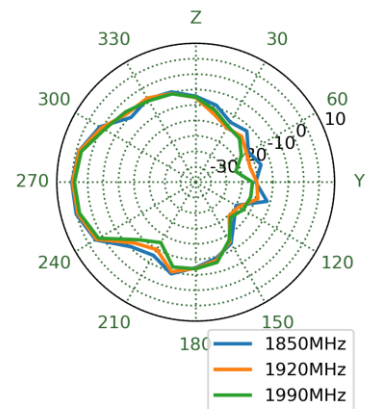
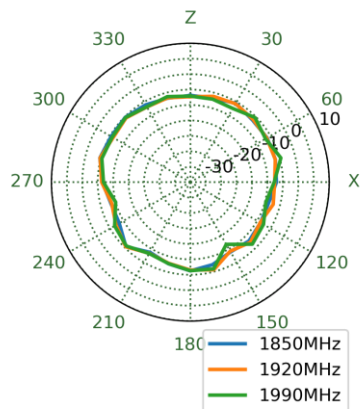
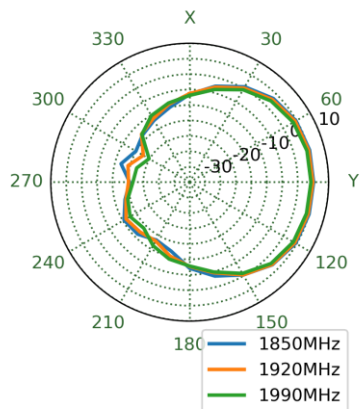

1990MHz

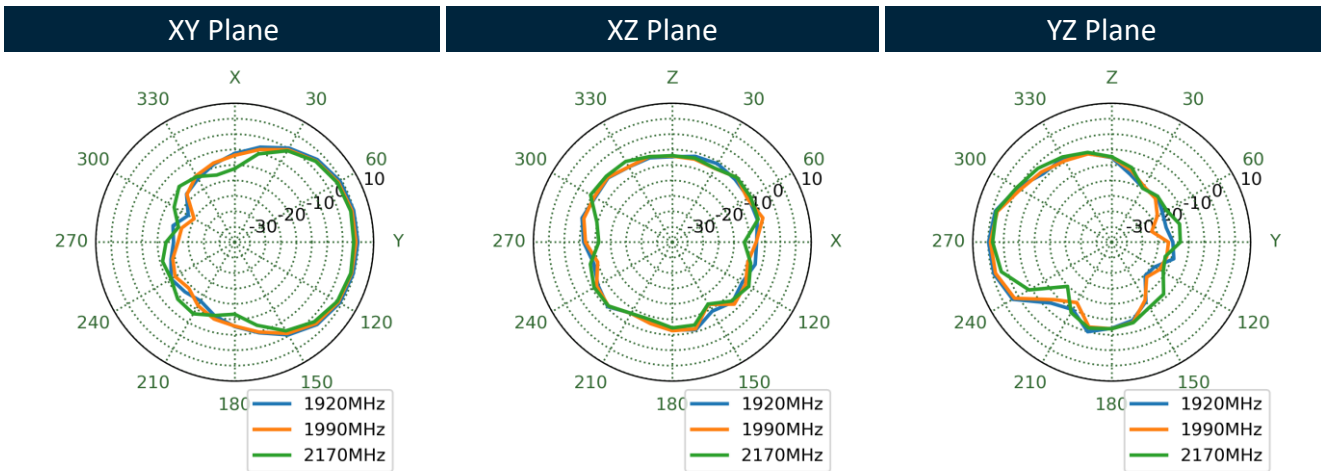
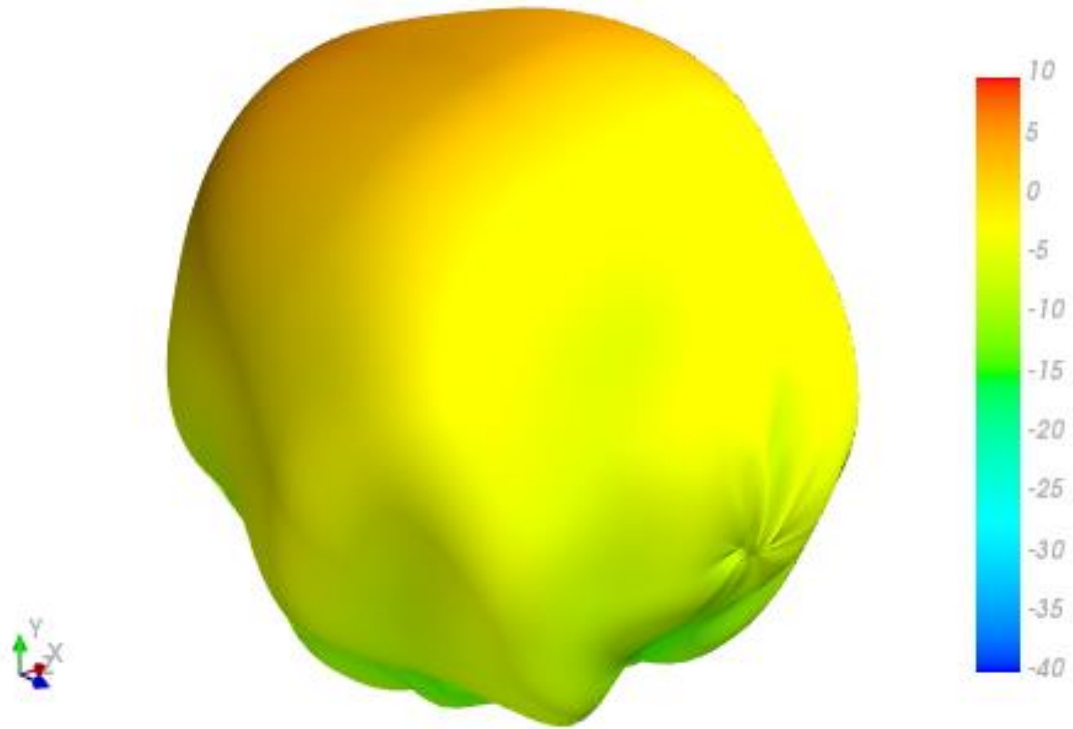

2595MHz

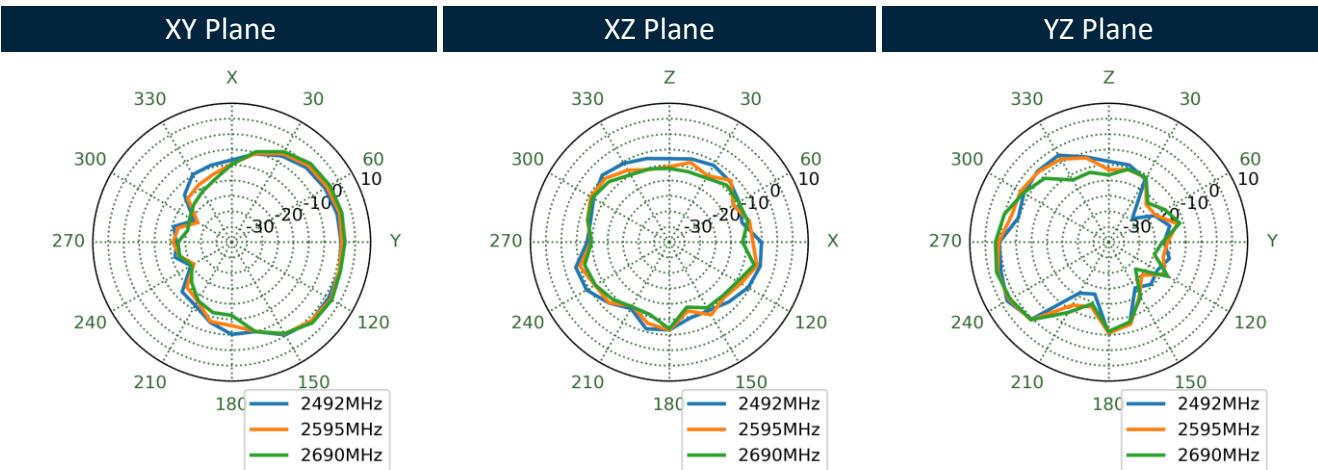
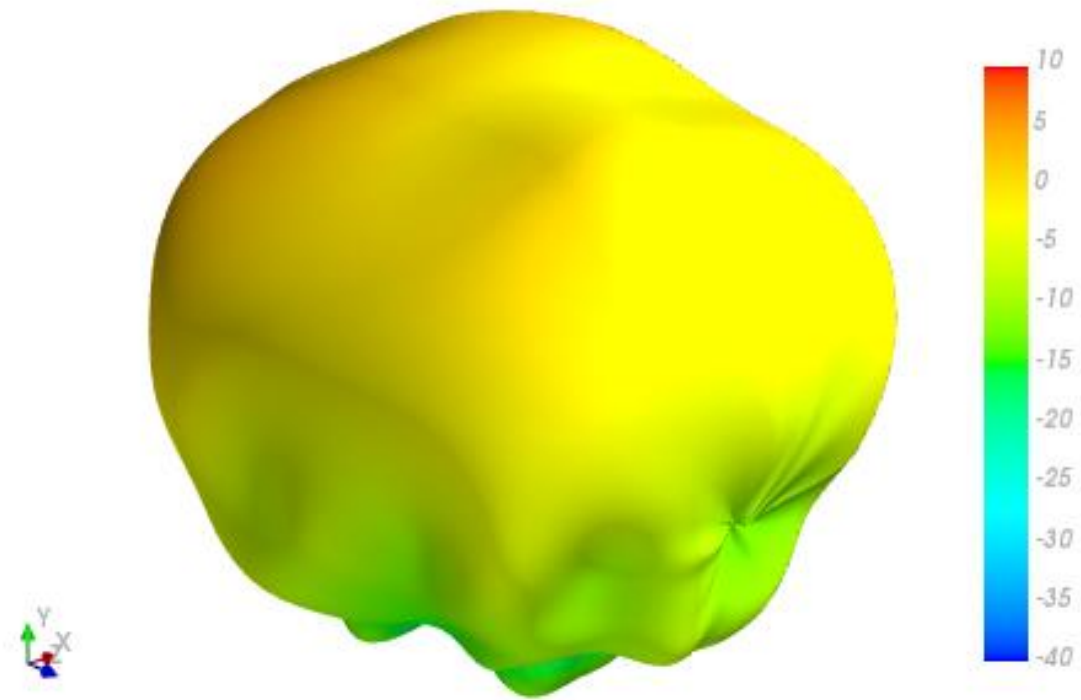

3550MHz

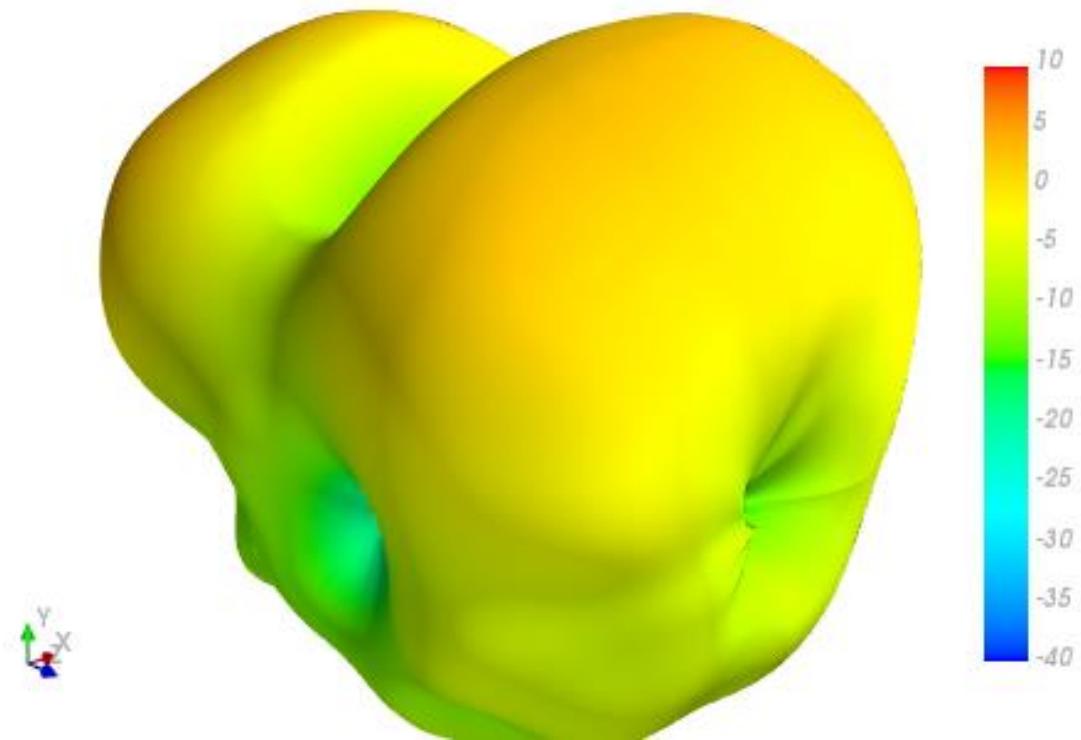

XY Plane

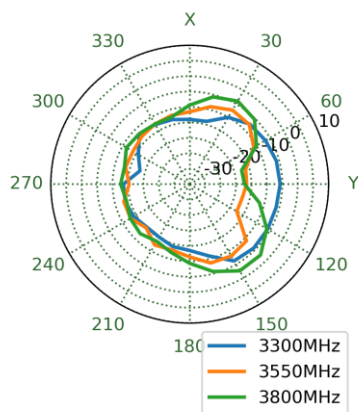

XZ Plane

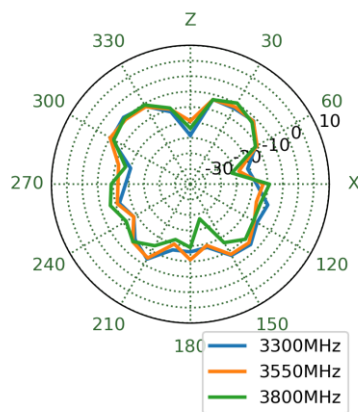

YZ Plane

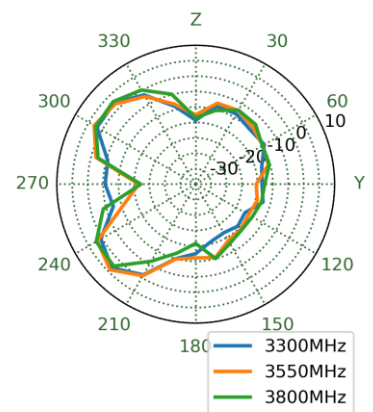

5530MHz

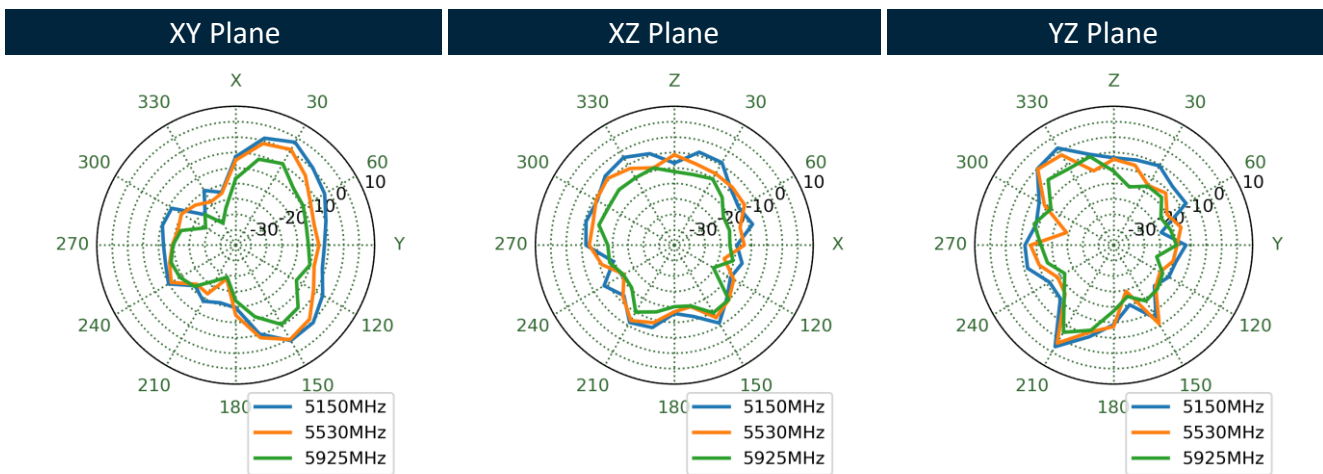
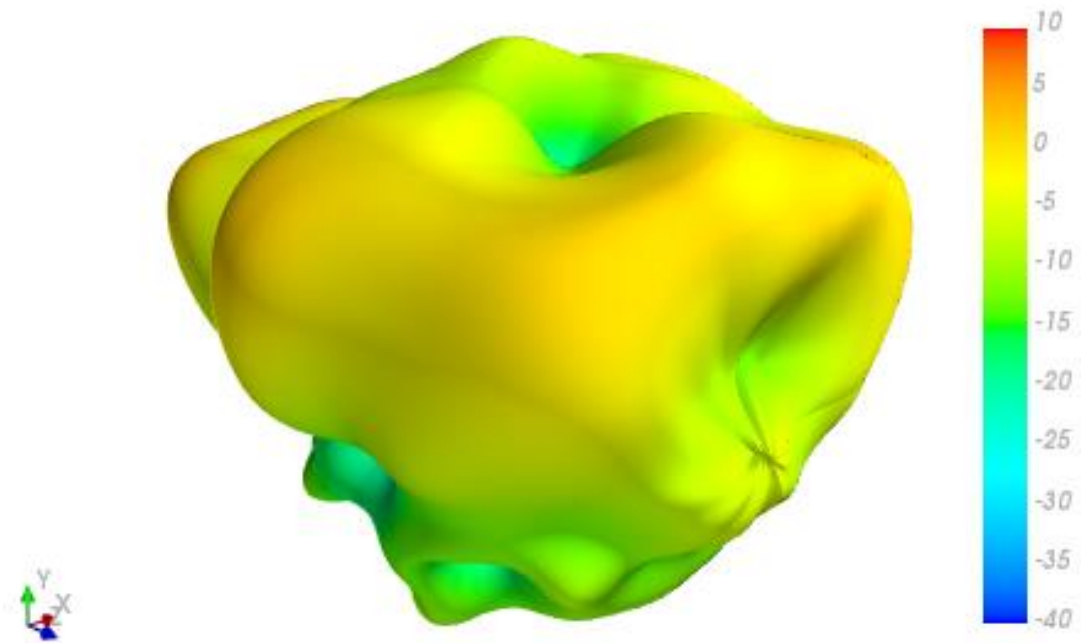



# 5. Mechanical Drawing (Units: mm)

ISO NO.: EDW-21-8-0806  
 STATE: Release  
 NOTES:

REV.	DESCRIPTION	ENG.	APPROVED	DATE
001	Initial Design	Ruby	Aaron	2021/07/02
002	Modify the Fakra and Dimension	Ruby	Aaron	2021/07/12

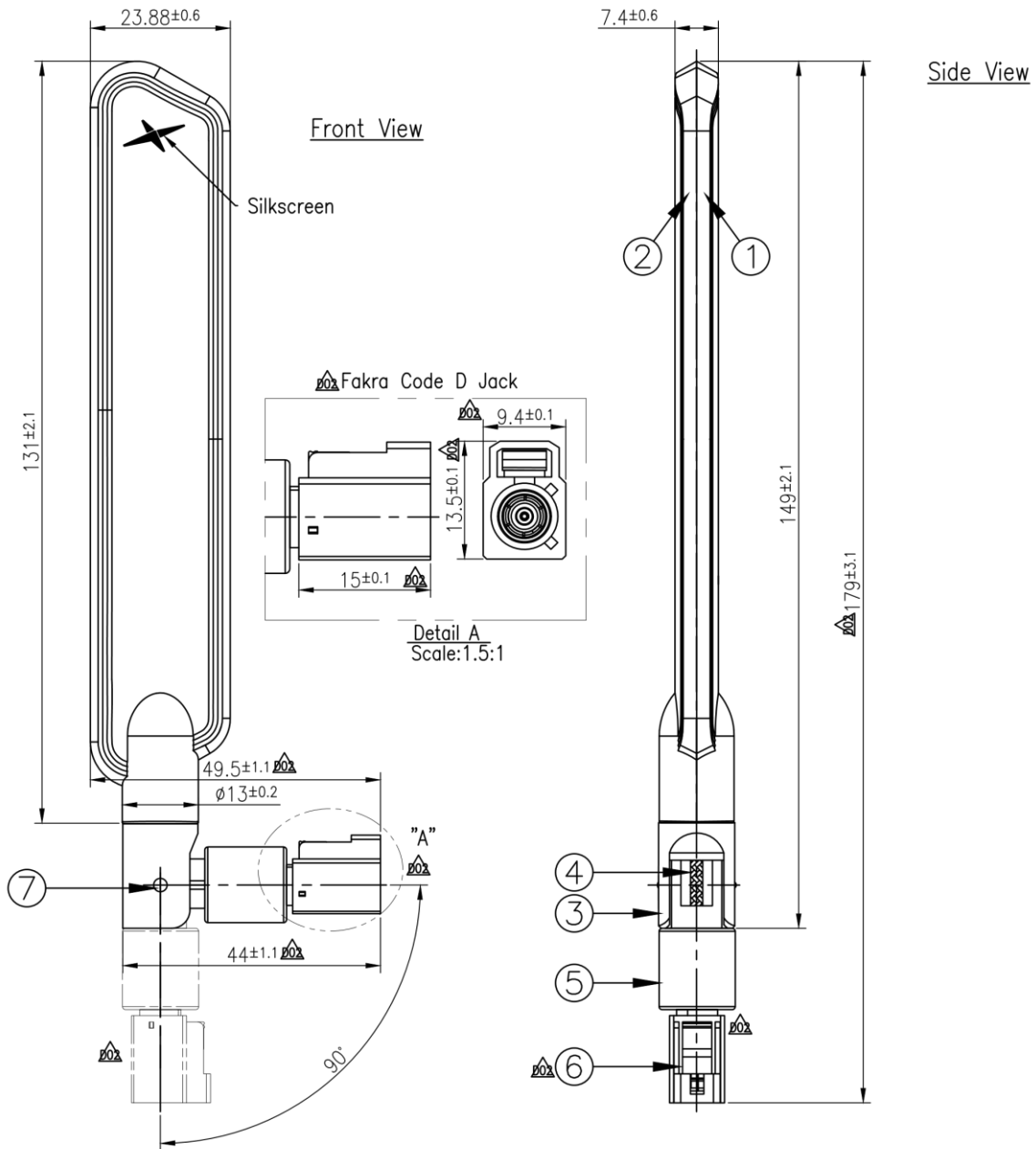

	Name	Material	Finish	QTY
1	Antenna Housing_Top	PC+ABS	Black	1
2	Antenna Housing_Bottom	PC+ABS	Black	1
3	Upper Base	PBT+PC	Black	1
4	RG178 Coaxial Cable	FEP	Brown	1
5	Bottom Base	PBT+PC	Black	1
6	FAKRA Code D SMB(F)	PA66	Violet	1
7	Rivet	PBT+PC	Black	2

APPROVED BY: Aaron	TW Design Centre <small>This drawing and its inherent design concepts are property of Taoglas. Not to be copied or given to third parties without the written consent of Taoglas.</small>
CHECK BY: Aaron	
DRAWN BY: Ruby	TITLE : 5G/4G Terminal Mount Monopole Antenna with 90° Hinged FAKRA Code D
DATE: 2021/07/02	PART NO. : TG.55.8723
<small>UNLESS OTHERWISE SPECIFIED TOLERANCES ON:</small> <small>XX:±0.5</small> <small>X:±0.3</small> <small>∅:±0.2</small> <small>XXX:±0.1</small> <small>XXXX:±0.05</small>	UNIT: mm
THIRD ANGLE PROJECTION	SCALE: 1:1
	PAGES: 1/1
	REV. D02

## 6. Packaging

1pc TG.55.8723 per Small PE Bag  
 Dimensions: 30\*210mm  
 Weight: 31g

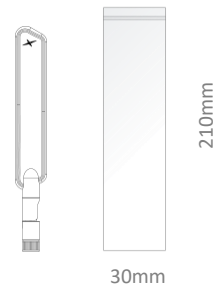

20pcs per Large PE Bag  
 Dimensions: 180\*265mm  
 Weight: 620g

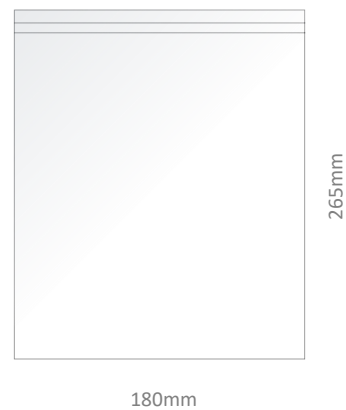

400pcs TG.55.8723 per Carton  
 Carton Dimensions: 320\*250\*230mm  
 Weight: 13Kg

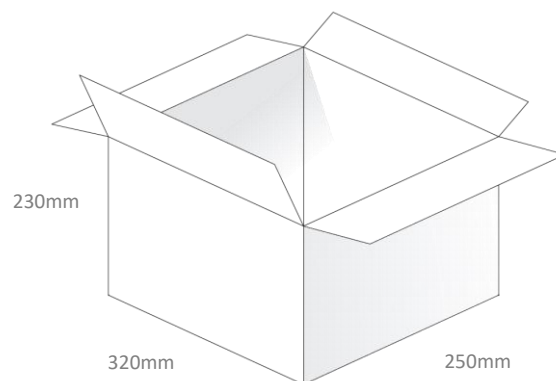

Pallet Dimensions:  
 1200\*1000\*1350mm  
 60 Cartons per Pallet  
 12 Cartons per layer, 5 Layers

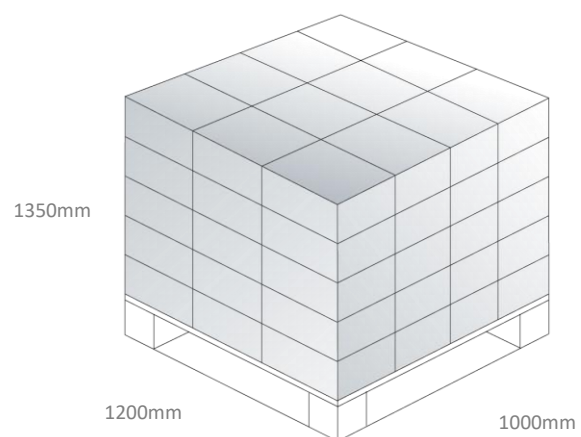

## 7. Application Note

### 3.1 Return Loss

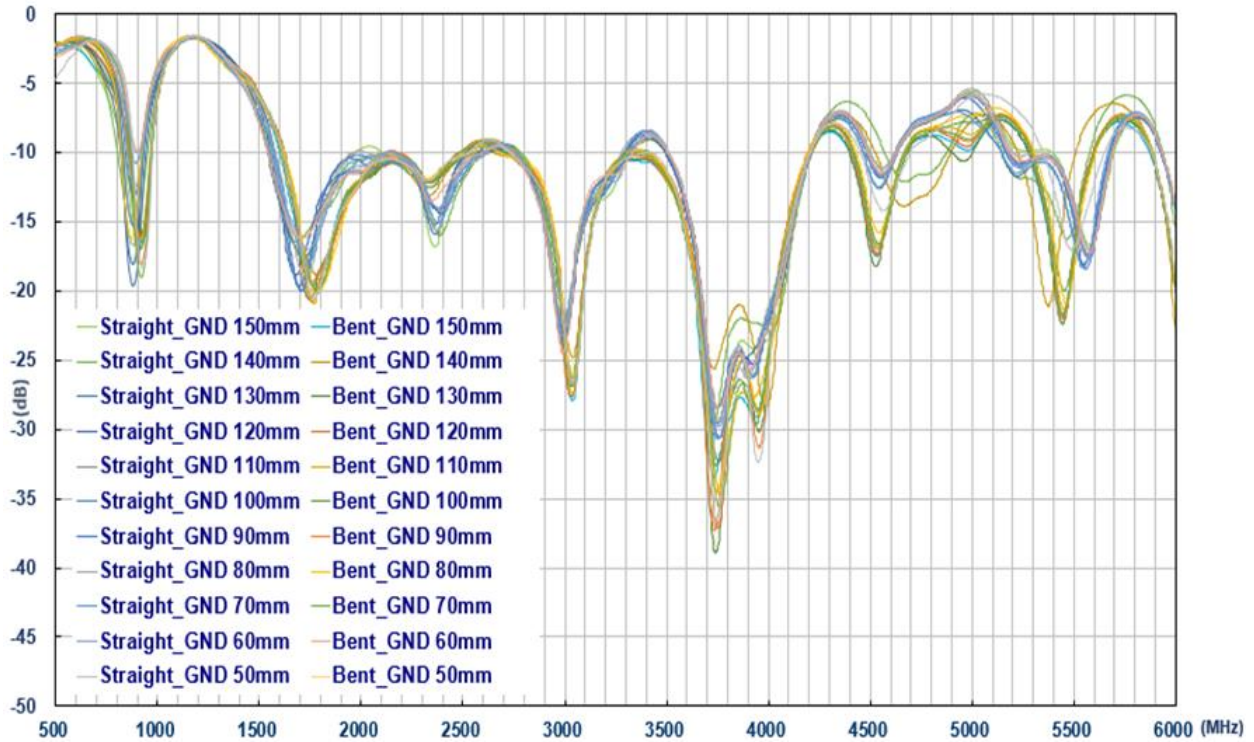

### 3.2 Efficiency

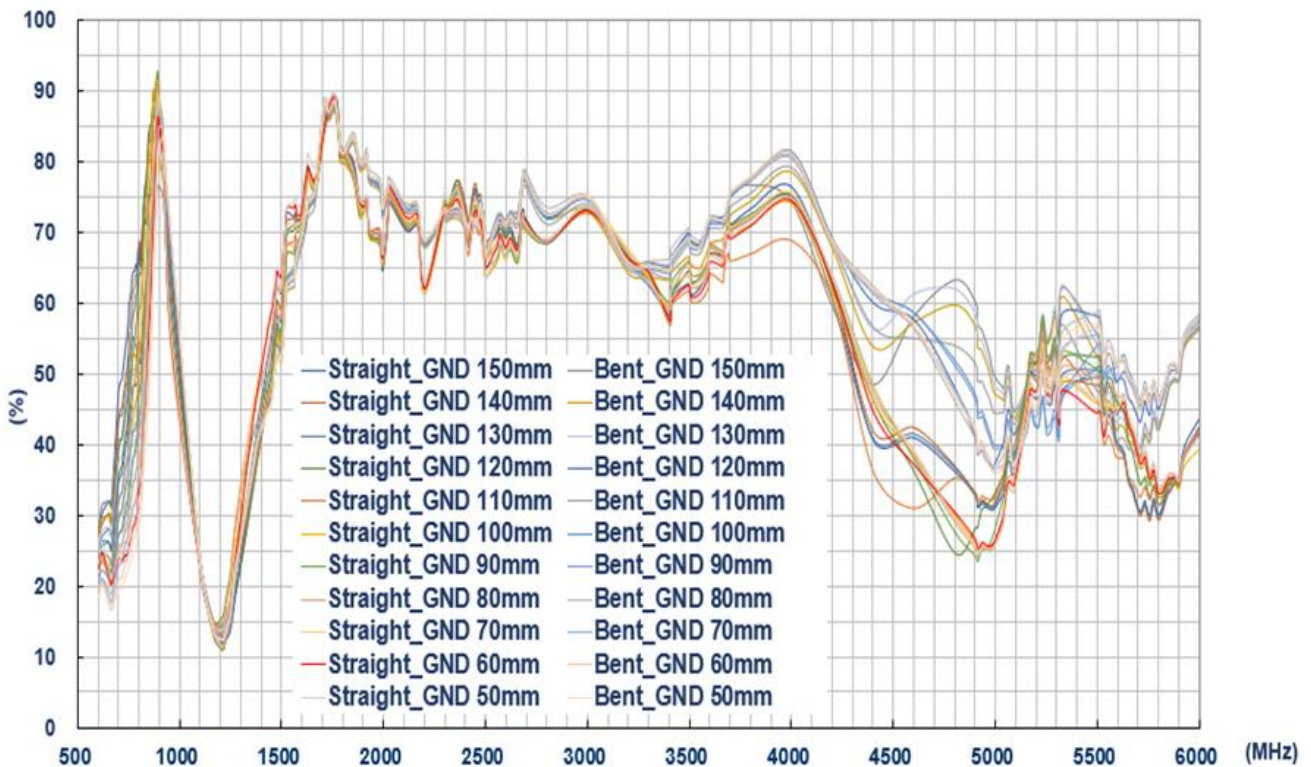

### 3.3 Average Gain

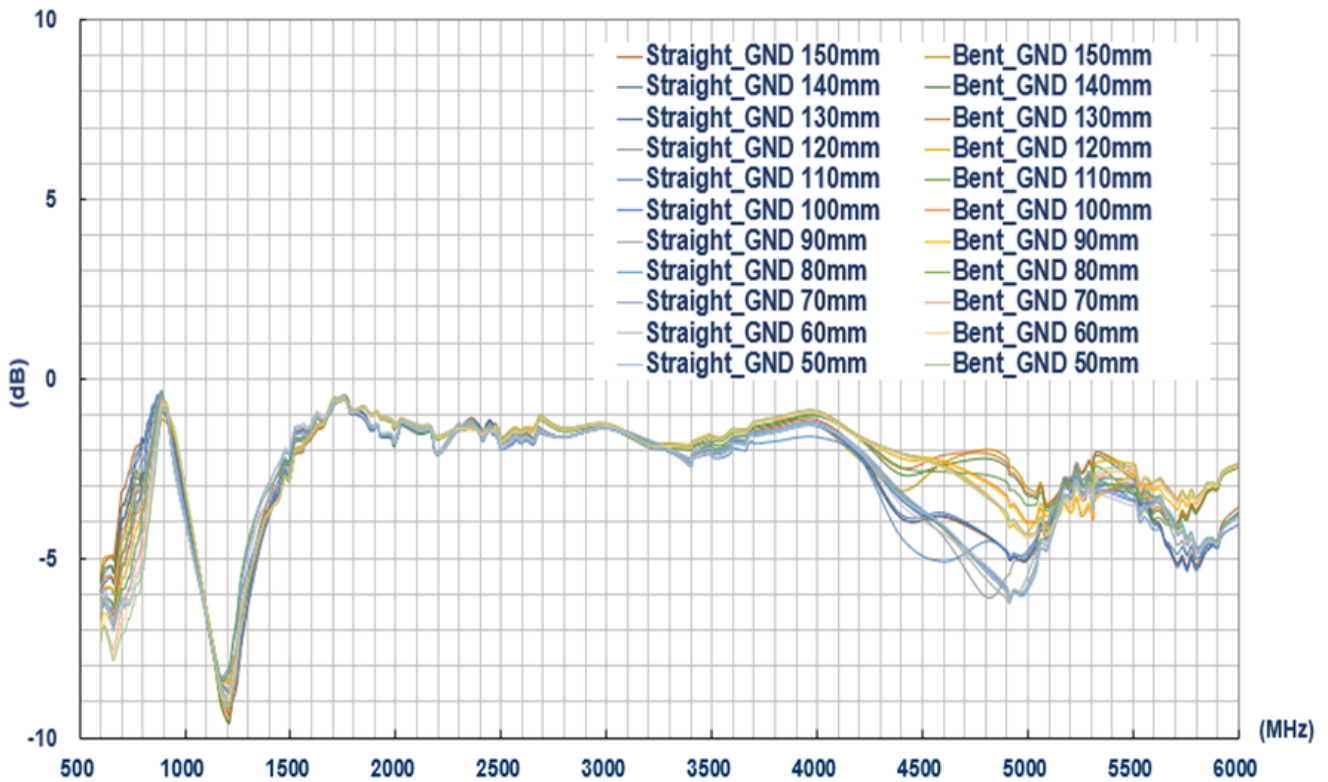

### 3.4 Peak Gain

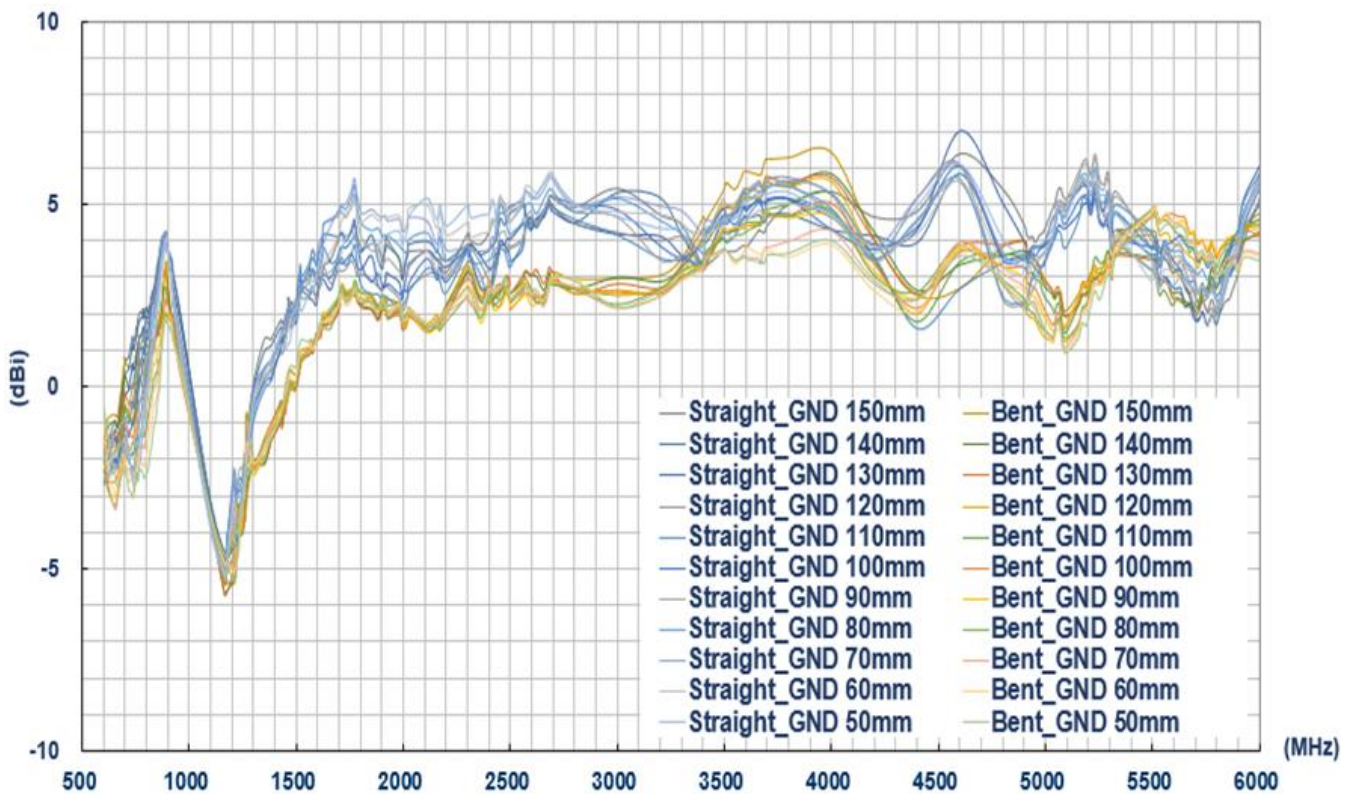

Changelog for the datasheet

**SPE-21-8-053 – TG.55.8723**

<b>Revision: A (Initial Launch)</b>	
Date:	2021-08-10
Changes:	Initial Specification Release
Changes Made by:	Jack Conroy

**Previous Revisions**

